

MOSFETs

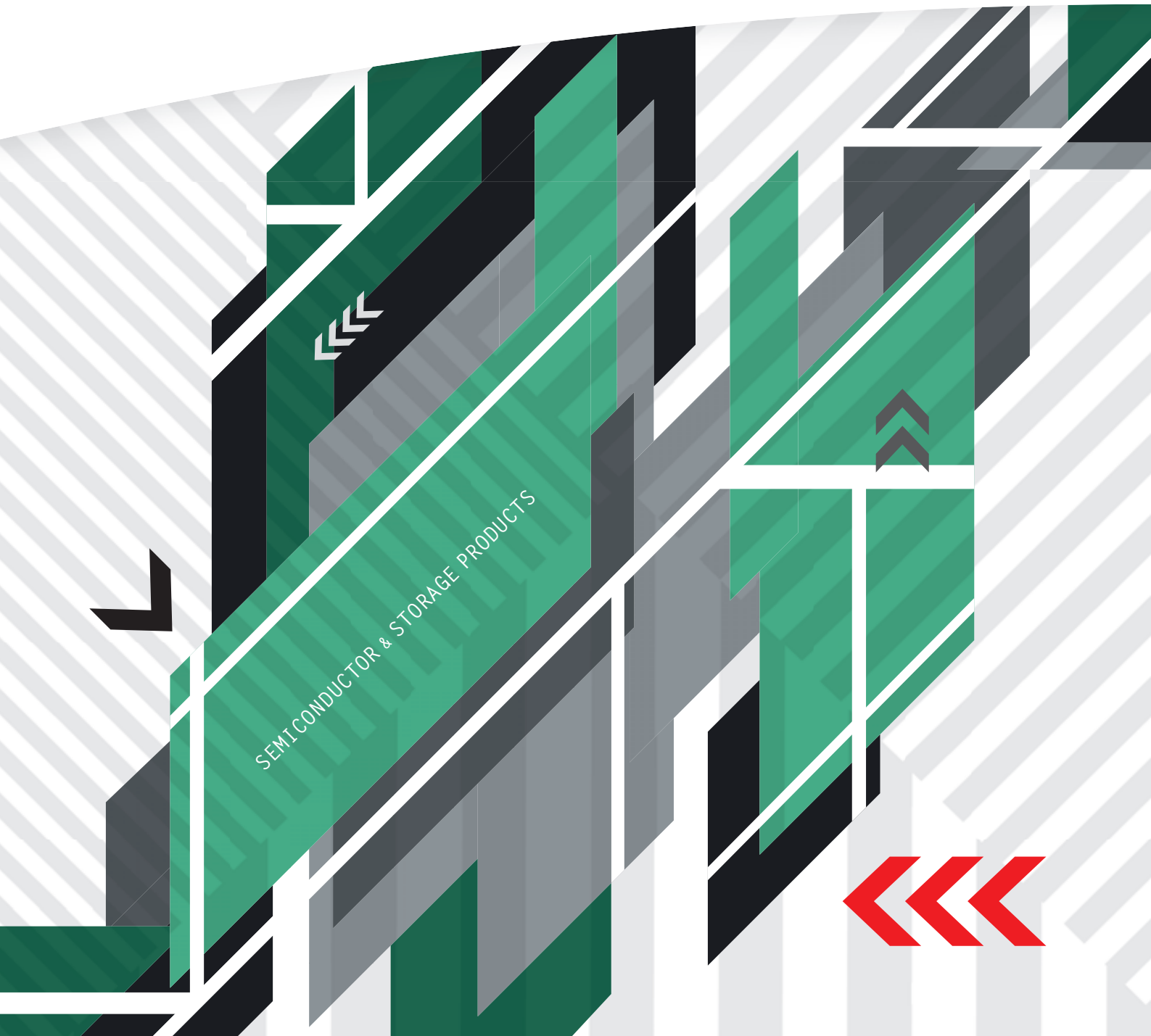

SEMICONDUCTOR & STORAGE PRODUCTS



Toshiba's MOSFETs Meet a Wide Range of Application Needs.

幅広いニーズに応える東芝のMOSFET

Toshiba offers an extensive portfolio of low- V_{DSS} and mid/high- V_{DSS} MOSFETs in various circuit configurations and packages, featuring high speed, high performance, low loss, low on-resistance, small packaging, etc. Toshiba has decades of experience in the development and manufacturing of MOSFETs. Its main products include the mid-to high-voltage DTMOS Series with a V_{DSS} of 600 V or so and the low-voltage U-MOS Series with a V_{DSS} of 12 V to 250 V.

東芝のMOSFETは、高速、高性能、低損失、低オン抵抗、小型パッケージなどの特長を有し、低耐圧品から中高耐圧品まで、幅広い構成とパッケージラインアップを提供しています。

開発と製造を長年にわたって手掛けてきており、現在では、耐圧600 Vを中心とした中高耐圧品DTMOSシリーズと、耐圧12 Vから250 Vの低耐圧品U-MOSシリーズを展開しています。

Structures of Toshiba MOSFETs 東芝MOSFETの構造

Trench Structure トレンチ形構造

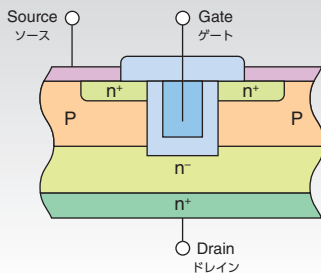

● U-MOS

Higher channel density is achieved by connecting channels vertically to form a U-groove at the gate region, a structure that yields a lower on-resistance than other MOSFET structures. The trench structure is primarily used for relatively low- V_{DSS} MOSFETs.

ゲートをU溝とし、チャンネルを縦方向に形成することで高集積化を実現し、低オン抵抗化をしています。この構造は比較的耐圧のMOSFETに使用されます。

Super-Junction Structure スーパージャンクション構造

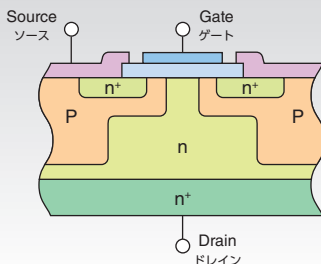

● DTMOS

The super-junction structure, which has P-type pillar layers as shown at left, realizes high withstand voltage and on-resistance lower than the conventional theoretical limit of silicon.

左図のように垂直方向にP層を形成することで高耐圧と低オン抵抗を合わせもった、従来のシリコンリミットを超越した特性を実現することができます。

Double-Diffusion Structure 二重拡散構造

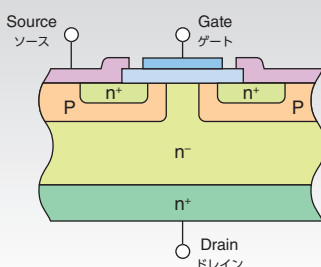

● π -MOS

Toshiba Power MOSFETs use a double-diffusion MOS (D-MOS) structure, which provides high withstand voltage, to form channels. This structure is especially well suited to high withstand voltage and high-current devices. A high level of integration yields a high-performance Power MOSFET with low on-resistance and low power loss.

二重拡散によりチャンネルを形成し、高耐圧を得るD-MOS(Double Diffusion MOS)と呼ばれる構造を採用しています。この構造は高耐圧・大電流化が容易です。また高集積化ができ、低オン抵抗・低損失で高性能のパワーMOSFETを実現することができます。

Low Voltage MOSFETs

低耐圧MOSFET

$V_{DSS} = 12\text{ V to }250\text{ V}$

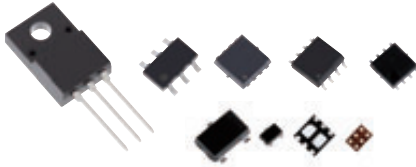

Applications アプリケーション

Page 4

High-Speed Switching Series 高速スイッチングシリーズ

Page 6

High-efficiency MOSFET series for AC-DC and DC-DC power supplies, fabricated using the latest Gen-8 and Gen-9 trench-gate process.

最新のトレンチ第8世代および第9世代プロセスを採用した、AC-DC電源/DC-DC電源向けに開発した高効率MOSFETシリーズです。

Low On-Resistance Series 低オン抵抗シリーズ

Page 12

Low on-resistance achieved by combining advanced trench-gate process and packaging technologies.

トレンチプロセス技術とパッケージ技術を融合させることで、低オン抵抗特性を実現したシリーズです。

Small Package Series 小型パッケージシリーズ

Page 14

Product series housed in small packages suitable for high-density board assembly for cell phone and other mobile applications.

携帯機器などの高密度実装に対応した小型パッケージシリーズです。

Mid-High Voltage MOSFETs

中高耐圧MOSFET

$V_{DSS} = 200\text{ V to }900\text{ V}$

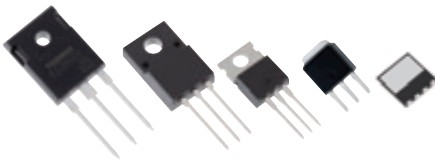

DTMOS Series DTMOSシリーズ

Page 18

The super-junction DTMOS Series achieves low on-resistance and low gate charge (Q_g) due to the use of the latest super-junction structure.

最新スーパージャンクション構造を適用することで、低オン抵抗・低容量を実現したシリーズです。

π -MOS Series π -MOSシリーズ

Page 20

The latest addition to the π -MOS portfolio, the π -MOSVII Series offers reduced capacitances due to optimized chip design and is available with a greatly wider range of electrical characteristics.

チップデザインの最適化により容量特性を低減、さらにラインアップを大幅に拡充した π -MOSの最新シリーズです。

Automotive MOSFETs

車載MOSFET



Automotive MOSFETs 車載MOSFET

Page 22

Automotive-grade MOSFETs feature low on-resistance, low capacitance, high current and high quality, and help improve the performance and reduce the power consumption of automotive applications.

低オン抵抗/低容量/大電流/高品質で、車載アプリケーションの性能改善と省エネに貢献します。

- List of Packages パッケージ一覧 Page 26
- Part Naming Conventions 品番付与法 Page 28
- Web Simulator Webシミュレーターのご紹介 Page 30

Applications アプリケーション

Toshiba offers U-MOSVIII-H and other series with a V_{DS} ranging from 12 V to 250 V. These MOSFET series combine advanced trench-gate process and packaging technologies to deliver low on-resistance and high-speed switching. Our product portfolio includes an extensive array of MOSFETs in small packages suitable for various applications.

耐圧12 Vから250 VのU-MOSVIII-Hシリーズを中心にラインアップを展開しています。優れたトレンチプロセス技術とパッケージ技術の融合により、低オン抵抗特性と高速スイッチング特性を実現、充実した小型パッケージラインアップにより、様々な用途に応じた製品を提供します。

■ MOSFET Lineup MOSFETラインアップ

For general specifications of the MOSFETs shown in block diagrams, see the product selection tables on the following pages.

ブロック図中表示されているMOSFETのラインアップは、下記ページを参照してください。

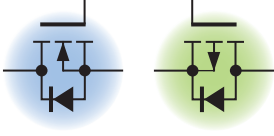
Block Diagrams ブロック図	Product Lineup 製品ラインアップ	Reference 参照ページ
<div style="border: 1px solid black; padding: 5px; margin-bottom: 5px;">AC-DC Power Supplies / AC Adapters AC-DC電源 / ACアダプタ</div> <div style="border: 1px solid black; padding: 5px; margin-bottom: 5px;">Isolated DC-DC Converters 絶縁型DC-DCコンバータ</div> <div style="border: 1px solid black; padding: 5px;">Non-isolated DC-DC Converters 非絶縁型DC-DCコンバータ</div>	<div style="border: 1px solid black; padding: 5px; background-color: #4CAF50; color: white;">High-speed switching 高速スイッチング用</div>	<p>High-Speed Switching Series 高速スイッチングシリーズ Page 6 to 11</p> <p>Small Package Series 小型パッケージシリーズ Page 14 to 17</p>
	<div style="border: 1px solid black; padding: 5px; background-color: #4CAF50; color: white;">High-speed switching 高速スイッチング用</div> <div style="border: 1px solid black; padding: 5px; background-color: #2196F3; color: white; margin-top: 5px;">Load switches ロードスイッチ用</div>	<p>High-Speed Switching Series 高速スイッチングシリーズ Page 6 to 11</p> <p>Low On-Resistance Series 低オン抵抗シリーズ Page 12 to 13</p> <p>Small Package Series 小型パッケージシリーズ Page 14 to 17</p>

■ Application Example for a Mobile Device 携帯機器の充電回路例

As the battery capacity for mobile devices increases, the charging current also increases. To meet the high-current need, Toshiba offers MOSFETs in small packages featuring high power dissipation. These MOSFETs are suitable for switching applications in high-current charger circuits.

携帯電話の電池容量が増大するなか、充電電流も増加する傾向にあります。このような大電流対応を実現するべく、高許容損失の小型パッケージに製品展開しました。大電流充電回路のスイッチ用途として適しています。

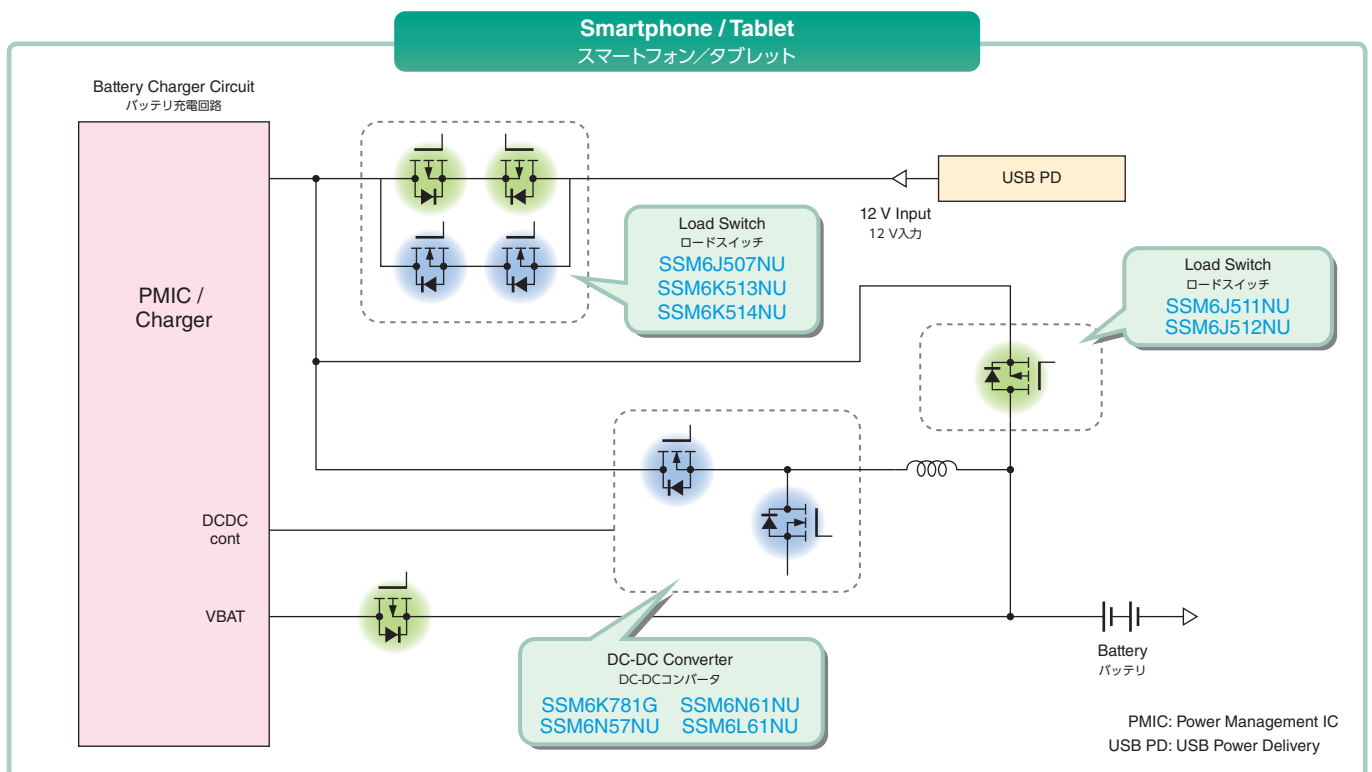

Power Supply for a Communication Base Station

通信基地局電源

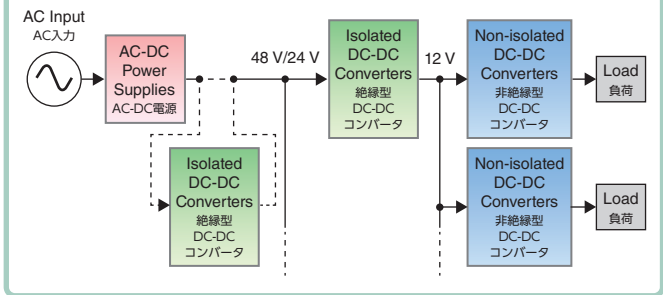

Power Supply for a Server

サーバ電源

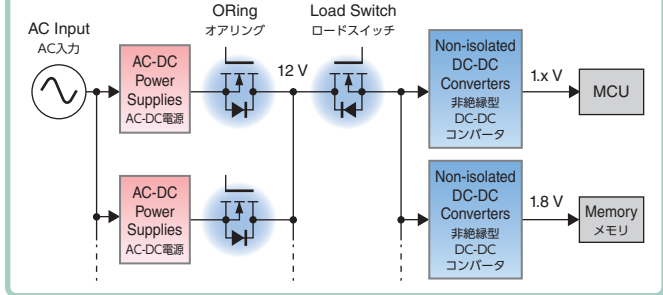

Power Supply for a Desktop PC

デスクトップPC用電源

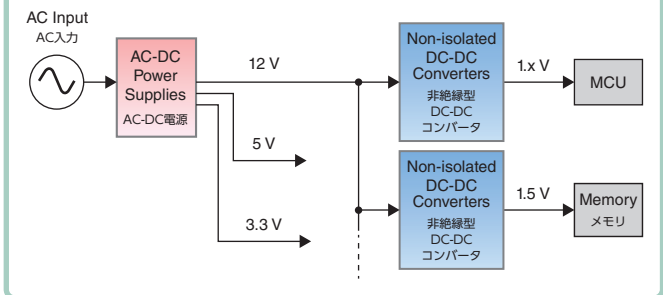

LCD Television

液晶TV

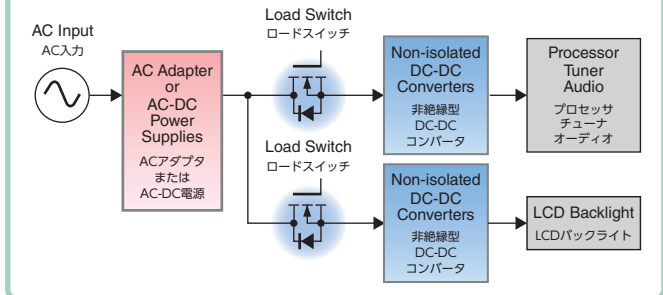

Uninterruptible Power Supply (UPS)

UPS (無停電電源装置)

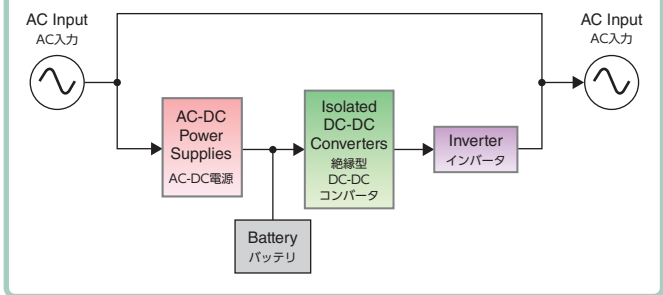

Motor Control

モータ制御

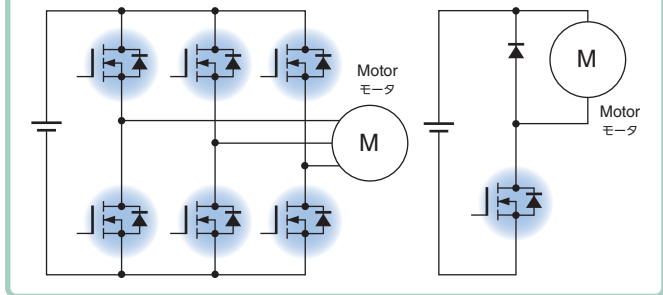

Internal Power Supply of a Notebook PC / AC Adapter / Battery Pack

ノートPC内部電源/ACアダプタ/バッテリー

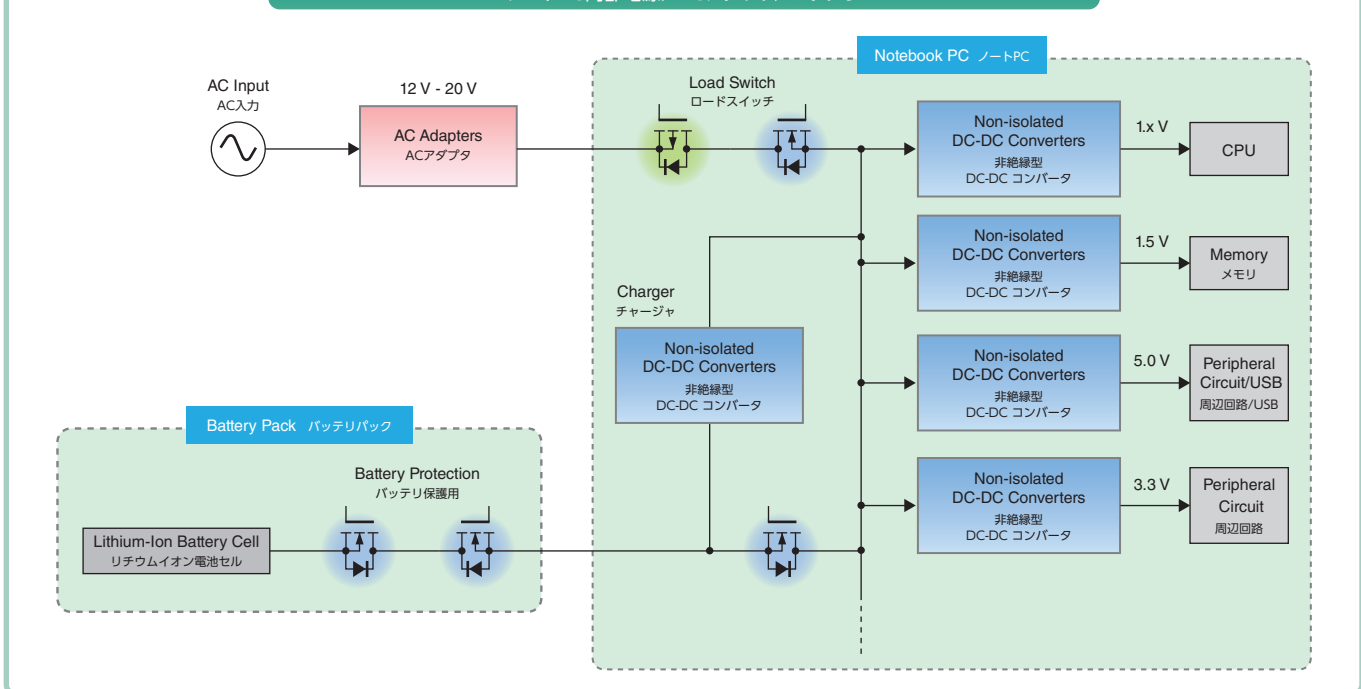

High-Speed Switching Series

高速スイッチングシリーズ

U-MOSVIII-H and U-MOSIX-H are high-efficiency MOSFET series specifically designed for use in the secondary side of AC-DC power supplies for notebook PC adapters, game consoles, servers, desktop PCs, flat-panel displays, etc., as well as DC-DC power supplies for communication equipment, servers and data centers. Fabricated with the latest Gen-8 and Gen-9 trench MOS processes, U-MOSVIII-H and U-MOSIX-H will help improve the efficiency of power supplies.

ノートPCのアダプタ/ゲーム機/サーバ/デスクトップPC/フラットパネルディスプレイなど、様々なアプリケーションのAC-DC電源の2次側用途、あるいは、通信機器/サーバ/データセンタなどのDC-DC電源用途向けに開発した高効率MOSFETシリーズです。最新のトレンチMOS第8世代、および第9世代プロセスを採用しており、電源の高効率化に貢献します。

U-MOSVIII-H and U-MOSIX-H: Latest-generation trench MOS series

トレンチMOS最新世代 U-MOSVIII-H/U-MOSIX-H シリーズ

■ Features of the U-MOS Series U-MOSシリーズ製品の特長

- Fabricated with a Gen-8 and Gen-9 trench MOS process designed for various power supply applications
- On-resistance, $R_{DS(ON)}$, less than $1\text{m}\Omega$
TPHR9003NL: $R_{DS(ON)} = 0.77\text{m}\Omega$ ($V_{GS} = 10\text{V}$, $I_D = 30\text{A}$)
- Provides significantly better trade-offs between on-resistance and input capacitance
- Offers high avalanche ruggedness
- Available in various packages
- 各種電源向けに開発したトレンチMOS第8世代および第9世代プロセスを採用
- $1\text{m}\Omega$ を切る低オン抵抗 ($R_{DS(ON)}$) 製品をラインアップ
TPHR9003NL: $R_{DS(ON)} = 0.77\text{m}\Omega$ ($V_{GS} = 10\text{V}$, $I_D = 30\text{A}$)
- 低オン抵抗特性と低入力容量特性のトレードオフを大幅に改善
- 高アバランシェ耐量を実現
- 豊富なパッケージ

■ Package Lineup パッケージラインアップ

High-speed MOSFETs are mainly housed in small surface-mount packages that are ideal for space-critical applications.

パッケージは小型面実装タイプを中心に展開しており、高密度電子機器に適しています。

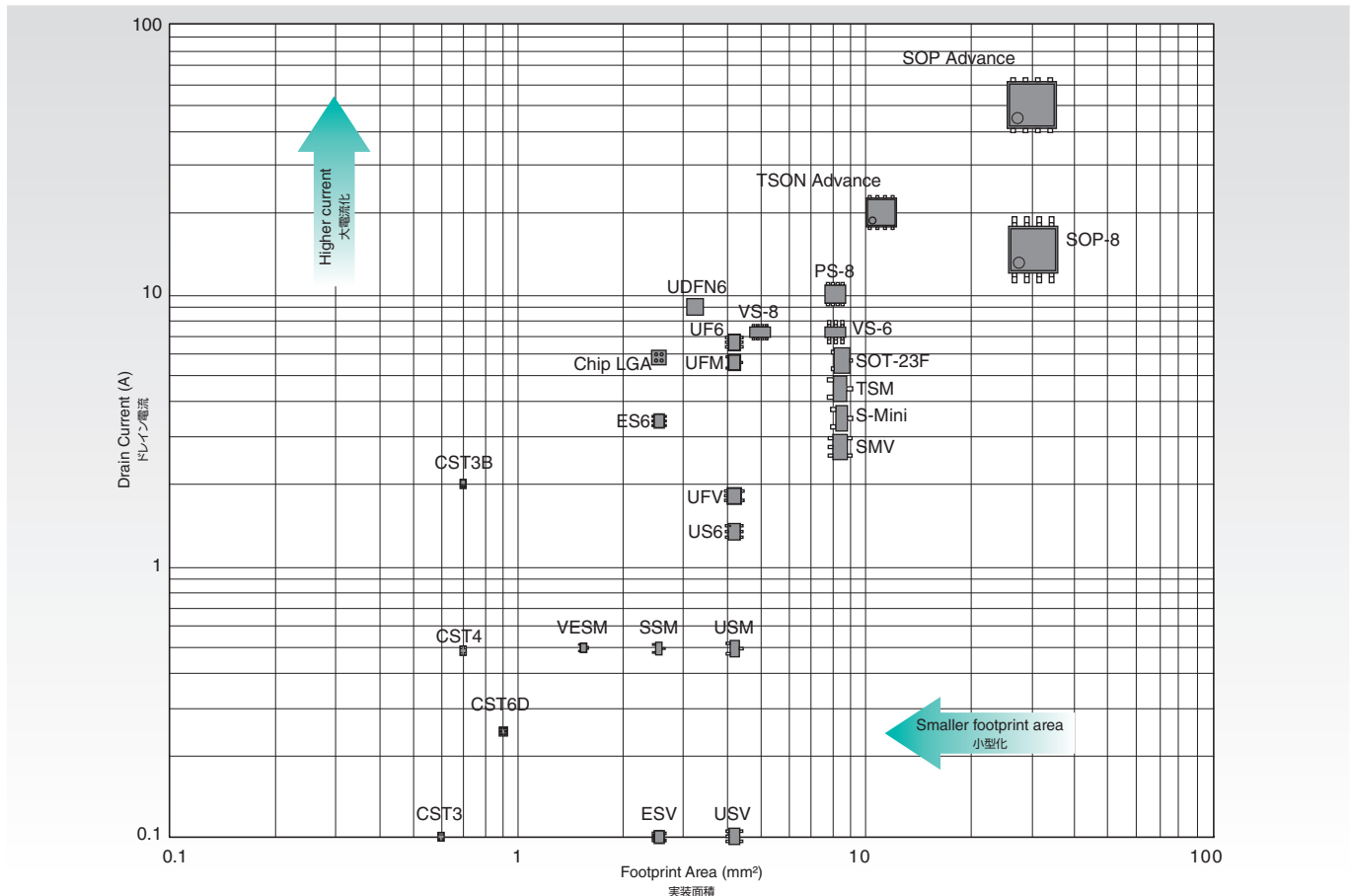
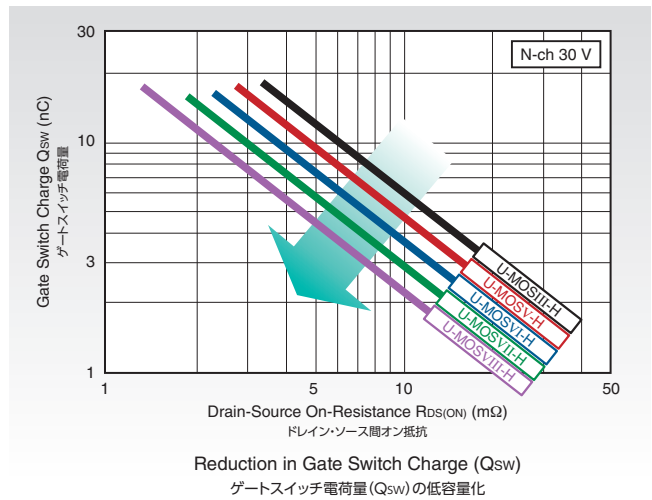

Non-isolated DC-DC Converters 非絶縁型DC-DCコンバータ

Smartphones and other sophisticated mobile devices, communication equipment and data processing devices contain many DC-DC converters. Although non-isolated DC-DC converter ICs are used for low output power applications, you can not only increase the output power by using discrete MOSFETs but also improve efficiency by combining optimal MOSFETs on the high side and low side.

スマートフォンなどの高性能なモバイル機器や、通信機器、データ処理機器には多数のDC-DCコンバータが搭載されています。非絶縁型DC-DCコンバータは小出力のものはICも使用されますが、単体MOSFETを用いることで高出力化できるだけでなく、ハイサイド/ローサイドの最適な組み合わせにより高効率化も図れます。

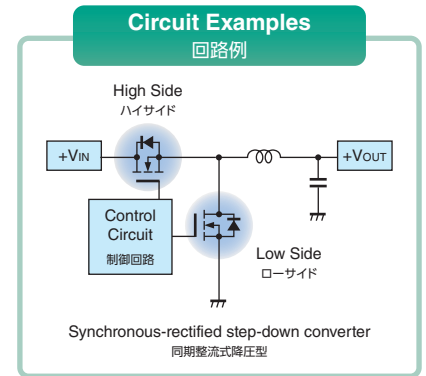

Features 特長

1. High-Speed Switching 高速スイッチング

The U-MOSVIII-H Series exhibits high-speed switching speed thanks to the industry's best Ron-Crss performance.

業界トップクラスのRon-Crss特性により、高速スイッチングを実現しています。

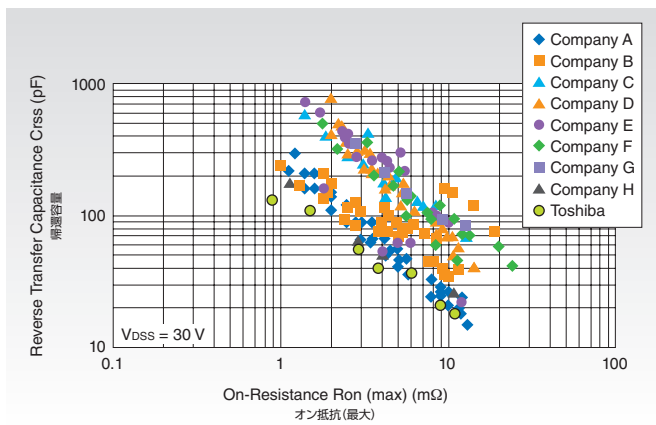

2. Reduced Switching Noise スイッチングノイズの低減

As a consequence of the snubber effect, the U-MOSVIII-H and U-MOSIX-H Series suppresses switching noise and ringing more effectively than the U-MOSVII-H Series.

U-MOSVIII-H/U-MOSIX-Hは、スナバ効果により、U-MOSVII-Hに対してノイズ、リンギングを低減しています。

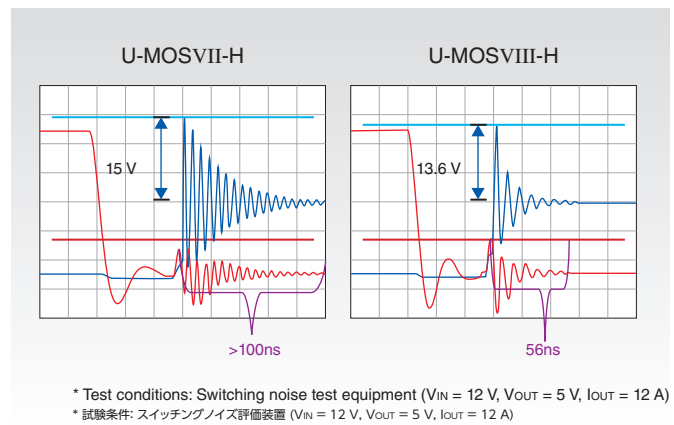

Recommended Products 推奨製品

The optimal pair of a high-side and a low-side MOSFET depends on the required output current. The following table gives examples of recommended MOSFET pairs according to the output current requirement.

出力に応じて最適なハイサイド/ローサイドの素子の組み合わせは変わります。下表は、出力に応じた推奨例となります。

Input-to-Output Voltage Ratio 降圧比		Output Current 出力電流					
		Up to 5 A	Up to 10 A	Up to 15 A	Up to 20 A	Up to 25 A	Up to 30 A
Up to 0.08 VIN = 19 V VOUT = 1 V	High Side ハイサイド	SSM3K333R TPCC8067-H	SSM6K504NU TPCC8066-H	TPCC8066-H TPN11003NL	TPN11003NL TPCC8065-H	TPCC8065-H TPN8R903NL	TPN8R903NL TPN6R003NL
	Low Side ローサイド	TPCC8066 TPN11003NL	TPN8R903NL	TPN6R003NL	TPN4R303NL TPCA8059-H TPH6R003NL	TPN4R303NL TPCA8057-H	TPN2R703NL TPH3R203NL TPCA8055-H
Up to 0.15 VIN = 12 V VOUT = 1 V	High Side ハイサイド	SSM6K504NU TPCC8067-H	SSM6K504NU TPCC8066-H TPN11003NL	TPN11003NL TPCC8065-H	TPCC8065-H TPCA8065-H TPN8R903NL	TPN8R903NL TPN6R003NL	TPN6R003NL
	Low Side ローサイド	TPCC8066 TPN11003NL	TPCC8065-H TPN8R903NL	TPN6R003NL	TPN4R303NL TPCA8059-H TPN6R003NL	TPN4R303NL TPCA8057-H	TPN2R703NL TPH3R203NL TPCA8055-H
Up to 0.5 VIN = 12 V VOUT = 5 V	High Side ハイサイド	SSM6K504NU TPCC8067-H TPN11003NL	TPCC8065-H TPN8R903NL	TPN8R903NL TPN6R003NL	TPN4R303NL TPCA8059-H TPN6R003NL	TPN4R303NL TPCA8057-H	
	Low Side ローサイド	SSM6K504NU TPCC8067-H TPN11003NL	TPCC8065-H TPN8R903NL	TPN6R003NL	TPN4R303NL TPCA8059-H TPN6R003NL	TPN4R303NL TPCA8057-H	

* Input-to-Output Voltage Ratio: Output_Voltage/Input_Voltage

* 降圧比: 入出力電圧の比 (出力電圧/入力電圧)

Isolated DC-DC Converters 絶縁型DC-DCコンバータ

Isolated DC-DC converters are widely used for two kinds of applications: 1) applications in which the output circuit must be isolated from the input circuit, and 2) those in which there is a large difference between input and output voltages. Forward, half-bridge and full-bridge DC-DC converters are used according to the required output power.

絶縁型DC-DCコンバータは、入力・出力間を絶縁する目的で使用される他、入力電圧比が高い場合にも使用されます。出力に応じてフォワード型、ハーフブリッジ型、フルブリッジ型が使い分けられます。

Circuit Examples 回路例

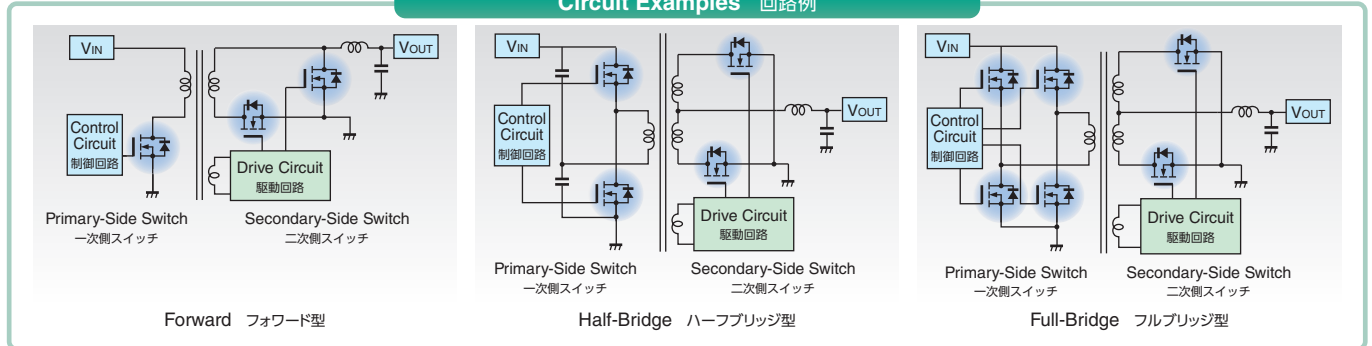

■ Features 特長

1. High-Speed Switching 高速スイッチング

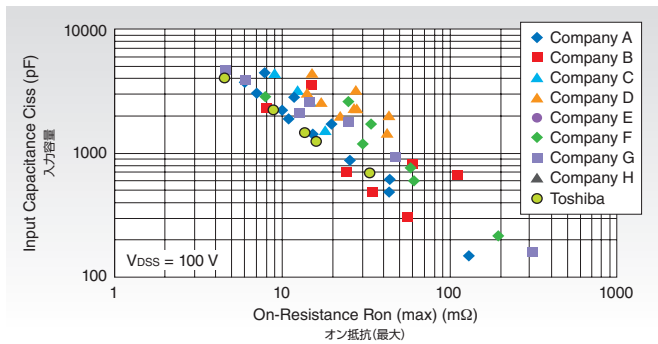

2. Improved Efficiency 効率の改善

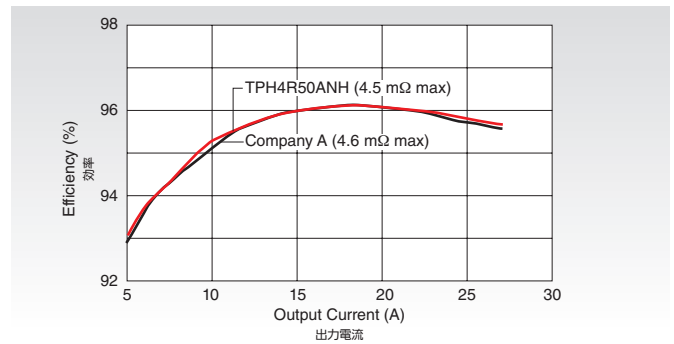

* Test conditions: 120-W full-bridge, $V_{IN} = 48$ VDC, $V_{OUT} = 12$ V same MOSFET on both the primary and secondary sides (four MOSFETs in two parallel circuit branches on the primary side)

* 測定条件: 120 Wフルブリッジ型, $V_{IN} = 48$ VDC, $V_{OUT} = 12$ V 1次側/2次側同一製品を使用。2次側は2個並列、4個使用。

■ Recommended Products 推奨製品

Drain-Source Voltage ドレイン・ソース間電圧 V_{DSS}	Output Power 出力電力					
	Up to 50 W Forward フォワード型	Up to 150 W Forward (Active Clamp) フォワード型(アクティブクランプ方式)	Up to 300 W Half-Bridge ハーフブリッジ型	Up to 500 W Full-Bridge フルブリッジ型	Up to 1000 W Full-Bridge フルブリッジ型	
Primary-Side Switch 一次側スイッチ	60 V			TPH4R606NH	TPH2R306NH	TPH2R306NH(2parallel)
	80 V			TPH8R008NH	TPH4R008NH TPW4R008NH	TPH4R008NH(4parallel) TPW4R008NH(4parallel)
	100 V			TPH8R80ANH	TPH4R50ANH TPW4R50ANH	TPH4R50ANH(4parallel) TPW4R50ANH(4parallel)
	150 V	TPN5900CNH TPH3300CNH				
	200 V	TPN1110ENH	TPH6400ENH			
250 V	TPH1110FNH					
Secondary-Side Switch 二次側スイッチ	30 V ($V_{OUT} = 3.3$ V)	TPN6R003NL TPH6R003NL TPN4R303NL TPH4R003NL	TPH1R403NL TPHR9003NL TPWR8503NL	TPHR9003NL(2parallel) TPWR8503NL	TPHR9003NL(4parallel) TPWR8503NL(2parallel)	TPHR9003NL(8parallel) TPWR8503NL(4parallel)
	40 V ($V_{OUT} = 5$ V)		TPH1R204PL	TPHR8504PL	TPHR8504PL(2parallel) TPWR8004PL	TPHR8504PL(4parallel) TPWR8004PL(2parallel)
	45 V ($V_{OUT} = 12$ V/5 V)			TPH1R005PL	TPH1R005PL(2parallel)	TPH1R005PL(4parallel)
	60 V ($V_{OUT} = 12$ V)	TPN22006NH	TPN14006NH TPN7R506NH	TPH5R906NH TPH4R606NH	TPH2R306NH(2parallel)	TPH2R306NH(2parallel)
	75 V ($V_{OUT} = 12$ V)				TPH2R608NH	TPH2R608NH(2parallel)
	80 V ($V_{OUT} = 12$ V)	TPN30008NH	TPN13008NH TPH8R008NH	TPH4R008NH TPW4R008NH	TPH4R008NH(2parallel) TPW4R008NH(2parallel)	TPH4R008NH(4parallel) TPW4R008NH(3parallel)
	100 V ($V_{OUT} = 12$ V)	TPN3300ANH	TPN1600ANH TPH8R80ANH	TPH4R50ANH TPW4R50ANH	TPH4R50ANH(2parallel) TPW4R50ANH(2parallel)	TPH4R50ANH(4parallel) TPW4R50ANH(3parallel)
	150 V ($V_{OUT} = 24$ V)	TPN5900CNH	TPH3300CNH	TPH1500CNH	TPH1500CNH(2parallel)	TPH1500CNH(4parallel)
200 V ($V_{OUT} = 36$ V)	TPN1110ENH	TPH6400ENH	TPH2900ENH	TPH2900ENH(2parallel)	TPH2900ENH(4parallel)	
250 V ($V_{OUT} = 48$ V)	TPN2010FNH	TPH1110FNH	TPH5200FNH	TPH5200FNH(2parallel)	TPH5200FNH(4parallel)	

AC-DC Converters (Synchronous Rectifier Section) AC-DCコンバータ (同期整流部)

Flyback power supplies have a very simple circuit configuration that consists of a minimal part count. They are suitable for low-power power supplies. Full-bridge power supplies are suitable for relatively high-power power supply applications in the range of 1 kW to 3 kW.

* See the section "Mid-High V_{DSS} MOSFETs" on pages 18 to 21 for a description and a list of MOSFETs for primary-side switching and PFC applications.

フライバック型は、シンプルさを追求した回路構成で、使用部品を極力省いた方式です。小容量電源に適しています。一方、フルブリッジ型は、比較的大容量の電源に向いており、1 kW~3 kWクラスの電源に最適です。

*一次側スイッチング/PFC用のMOSFETは、18~21ページの「中高耐圧MOSFET」をご参照ください。

Circuit Examples 回路例

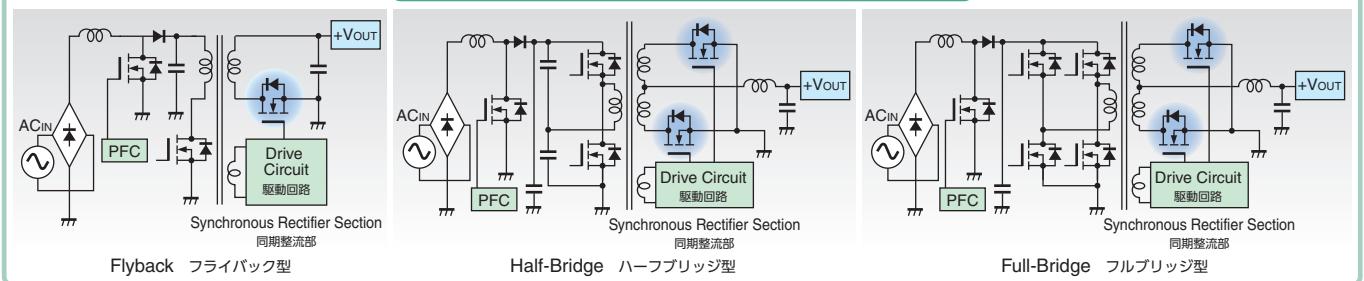

* PFC: Power Factor Correction 力率改善

■ Features 特長

1. Reduction of On-Resistance オン抵抗の低減化

The U-MOSVIII-H Series provides the industry's highest performance in terms of on-resistance per die area (RonA), making it ideal for applications that require higher efficiency, smaller size, etc.

U-MOSVIII-Hは業界最高水準の性能により、応用機器の効率改善、小型化等に大きく貢献します。

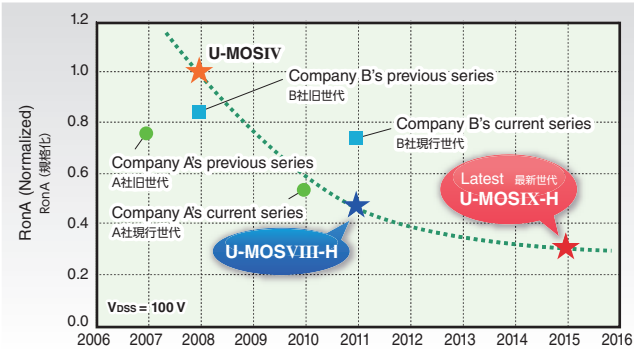

2. Improved Efficiency 効率の改善

The U-MOSVIII-H Series provides about the same efficiency as competitors' devices at heavy loads and higher efficiency at light loads.

他社製品と比較して、重負荷時では同等効率、軽負荷時では東芝U-MOSVIII-Hが特性優位を示しています。

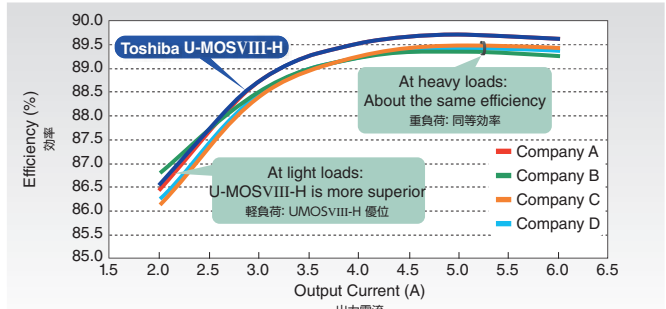

* Test conditions: 120 W adapter, V_{IN} = 100 VAC, V_{OUT} = 19.5 V, critical conduction mode (CRM)
* 測定条件: 120 Wアダプタ, V_{IN} = 100 VAC, V_{OUT} = 19.5 V, 出力電流臨界モード

■ Recommended Products (Synchronous Rectifier Section) 推奨製品 (同期整流部)

● Flyback フライバック型

V _{DSS}	Output Power 出力電力		
	Up to 20 W	Up to 50 W	Up to 100 W
60 V	TPN11006NL, TPH11006NL		
100 V		TK22A10N1, TK34A10N1 TK22E10N1, TK34E10N1	TK40A10N1, TK65A10N1, TK40E10N1, TK65E10N1 TK65G10N1
120 V		TK32A12N1, TK42A12N1 TK32E12N1, TK42E12N1	TK56A12N1, TK72A12N1 TK56E12N1, TK72E12N1

● Half-Bridge ハーブリッジ型

V _{DSS}	Output Power 出力電力			
	Up to 100 W	Up to 200 W	Up to 400 W	Up to 800 W
40 V		TPH1R204PL	TPHR8504PL	TPHR8504PL(2parallel)
45 V			TPH1R005PL	TPH1R005PL(2parallel)
60 V	TK30A06N1, TK30E06N1, TPN11006NL TPH11006NL, TPN14006NL, TPH14006NH	TK40A06N1, TK40E06N1 TPH7R506NH, TPN7R506NH	TK58A06N1, TK58E06N1 TPH4R606NH	TK100A06N1, TK100E06N1 TPH2R306NH
80 V	TK35A08N1, TK35E08N1 TPH12008NH, TPN13008NH	TK46A08N1, TK46E08N1 TPH8R008NH	TK72A08N1, TK72E08N1 TPH4R008NH	TK100A08N1, TK100E08N1 TPH4R008NH(2parallel)
100 V	TK34A10N1, TK34E10N1 TPH1400ANH, TPN1600ANH	TK40A10N1, TK40E10N1 TPH8R80ANH	TK65A10N1, TK65E10N1 TK65G10N1, TPH4R50ANH	TK100A10N1, TK100E10N1 TPH4R50ANH(2parallel)
120 V	TK32A12N1, TK32E12N1	TK42A12N1, TK42E12N1	TK56A12N1, TK56E12N1	TK72A12N1, TK72E12N1

● Full-Bridge フルブリッジ型

V _{DSS}	Output Power 出力電力		
	Up to 1 kW	Up to 2 kW	Up to 3 kW
40 V	TPHR8504PL	TPHR8504PL(2parallel)	TPHR8504PL(4parallel)
45 V	TPH1R005PL	TPH1R005PL(2parallel)	TPH1R005PL(4parallel)
60 V	TK100A06N1, TK100E06N1 TPH2R306NH	TK100A06N1(2parallel), TK100E06N1(2parallel) TPH2R306NH(2parallel)	TK100A06N1(4parallel), TK100E06N1(4parallel) TPH2R306NH(4parallel)
75 V	TPH2R608NH	TPH2R608NH(2parallel)	TPH2R608NH(4parallel)
80 V	TK100A08N1, TK100E08N1 TPH4R008NH(2parallel)	TK100A08N1(2parallel), TK100E08N1(2parallel) TPH4R008NH(4parallel)	TK100A08N1(4parallel) TK100E08N1(4parallel)
100 V	TK100A10N1, TK100E10N1 TPH4R50ANH(2parallel)	TK100A10N1(2parallel), TK100E10N1(2parallel) TPH4R50ANH(4parallel)	TK100A10N1(4parallel) TK100E10N1(4parallel)
120 V	TK72A12N1, TK72E12N1	TK72A12N1(2parallel) TK72E12N1(2parallel)	TK72A12N1(4parallel) TK72E12N1(4parallel)

High-Speed Switching Series Designed for General-Purpose Switching Power Supply Applications
高速スイッチングシリーズ 汎用スイッチング電源用

■ Single N-ch (V_{DSS} = 30 V to 80 V) シングルNチャンネル

I _D (A)	V _{DSS} (V)											
	30 V	R _{DS(ON)} (mΩ)	40 V	R _{DS(ON)} (mΩ)	45 V	R _{DS(ON)} (mΩ)	60 V	R _{DS(ON)} (mΩ)	75 V	R _{DS(ON)} (mΩ)	80 V	R _{DS(ON)} (mΩ)
5							TPCP8007-H	57				
5.3			TPC6009-H	81								
5.9	TPC6008-H	60										
6.1							TPC6010-H	59				
7.2			TPC8089-H	32								
9	TPC8067-H TPCC8067-H	25 25					TPC8053-H TPN22006NH	22.5 22				
9.6											TPN30008NH	30
11	TPC8066-H TPCC8066-H TPH11003NL TPN11003NL	16 15 11 11					TPC8050-H	14.5				
12			TPC8052-H	11.5								
13	TPC8065-H TPCC8065-H TPCC8068-H	11.4 11.6 11.6					TPC8049-H TPN14006NH	10.7 14			TPC8051-H	9.7
14							TPH14006NH*	14				
15	TP89R103NL TPCA8068-H	9.1 11.6	TK15S04N1L*	17.8			TPCA8053-H	22.3				
16	TPC8064-H TPCA8065-H	8.4 11.4	TPC8047-H	7.6			TPC8048-H	6.9				
17	TPC8063-H	7					TPH11006NL TPN11006NL	11.4 11.4				
18	TP86R203NL TPC8055-H TPC8056-H TPC8057-H TPC8058-H TPC8059-H TPC8062-H	6.2 2.1 2.4 2.8 3.2 4 5.8	TPC8045-H TPC8046-H	3.9 5.7							TPN13008NH*	13.3
19	TPCC8064-H	8.2										
20	TPCA8064-H TPH8R903NL TPN8R903NL	8.2 8.9 8.9	TK20P04M1 TPCA8052-H	29 11.3								
22	TPCA8063-H	6.8					TPH7R506NH*	7.5				
24											TPH12008NH	12.3
25							TK25S06N1S**	18.5				
26							TPN7R506NH	7.5				
27	TPCC8062-H TPN6R003NL	5.6 6										
28	TPCA8062-H	5.6					TPCA8049-H TPH5R906NH*	10.4 5.9			TPCA8051-H	9.4
30							TK30A06N1 TK30E06N1	15 15				
32	TPCA8059-H	3.8	TPCA8047-H	7.3			TPH4R606NH*	4.6				
34											TPH8R008NH*	8
35	TPCA8091-H*	6					TPCA8048-H	6.6			TK35A08N1 TK35E08N1	12.2 12.2
38	TPCA8058-H TPH6R003NL	3 6	TPCA8046-H	5.4								
40	TK40P03M1 TPH4R003NL TPN4R303NL	10.8 4 4.3	TK40P04M1	11			TK40A06N1 TK40E06N1	10.4 10.4				
42	TPCA8057-H	2.6										
45	TK45P03M1 TPN2R703NL	9.7 2.7										
46			TPCA8045-H	3.6							TK46A08N1 TK46E08N1	8.4 8.4
47	TPH3R203NL	3.2										
48	TPCA8056-H	2.2										
50	TK50P03M1	7.5	TK50A04K3 TK50P04M1	3.5 8.7								
56	TPCA8055-H	1.9										
58							TK58A06N1 TK58E06N1	5.4 5.4				
60	TPH1R403NL TPHR9003NL	1.4 0.9					TPH2R306NH*	2.3			TPH4R008NH	4
65			TK65S04N1L*	4.3								
72											TK72A08N1 TK72E08N1	4.5 4.3
80			TK80A04K3L	2.4					TK80A08K3	4.5		
90							TK90S06N1S**	3.3				
100			TK100S04N1L*	2.3			TK100A06N1 TK100E06N1	2.7 2.3			TK100A08N1 TK100E08N1	3.2 3.2
116											TPW4R008NH*	4
150	TPWR8503NL*	0.85	TPH1R204PL* TPHR8504PL* TPWR8004PL*	1.24 0.85 0.8	TPH1R005PL*	1.04			TPH2R608NH TPW2R508NH*	2.6 2.5		
200			TK200F04N1L*	0.9								

*: New Product **: Under Development
*: 新製品 **: 開発中

■ Single N-ch (V_{DSS} = 100 V to 250 V) シングルNチャンネル

I _D (A)	V _{DSS} (V)									
	100 V	R _{DS(ON)} (mΩ)	120 V	R _{DS(ON)} (mΩ)	150 V	R _{DS(ON)} (mΩ)	200 V	R _{DS(ON)} (mΩ)	250 V	R _{DS(ON)} (mΩ)
5.6									TPH2010FNH TPN2010FNH	198 198
7.2							TPH1110ENH TPN1110ENH	114 114		
8	TK8A10K3	120								
9					TPH5900CNH TPN5900CNH	59 59				
9.4	TPN3300ANH	33								
10									TPH1110FNH	112
12	TK12A10K3	80								
13							TPH6400ENH	64		
17	TPN1600ANH	16								
18	TK18E10K3	42			TPH3300CNH	33				
22	TK22A10N1 TK22E10N1	13.8 13.8								
24	TPH1400ANH*	13.6								
25	TK25A10K3	40								
26									TPH5200FNH TPW5200FNH*	52 52
32	TPH8R80ANH*	8.8	TK32A12N1 TK32E12N1	13.8 13.8						
33	TK33S10N1H**	9.7					TPH2900ENH TPW2900ENH*	29 29		
34	TK34A10N1 TK34E10N1	9.5 9.5								
38					TPH1500CNH TPW1500CNH*	15.4 15.4				
40	TK40A10N1 TK40E10N1	8.2 8.2								
42			TK42A12N1 TK42E12N1	9.4 9.4						
55	TK55S10N1*	6.5								
56			TK56A12N1 TK56E12N1	7.5 7						
60	TPH4R50ANH*	4.5								
65	TK65A10N1 TK65E10N1 TK65G10N1	4.8 4.8 4.5								
72			TK72A12N1 TK72E12N1	4.5 4.4						
92	TPW4R50ANH*	4.5								
100	TK100A10N1 TK100E10N1	3.8 3.4								
160	TK160F10N1*	2.4								

*: New Product
*: 新製品
**: Under Development
**: 開発中

■ Dual N-ch x 2 デュアルNチャンネル × 2

I _D (A)	V _{DSS} (V)							
	30 V	R _{DS(ON)} (mΩ)	40 V	R _{DS(ON)} (mΩ)	60 V	R _{DS(ON)} (mΩ)	80 V	R _{DS(ON)} (mΩ)
3.2							TPC8229-H	80
3.8					TPC8228-H	57		
5.1			TPC8227-H	33				
6.5	TPCP8205-H	26						
8	TPC8224-H	26						
9	TPC8223-H	17						

■ Built-in Schottky Barrier Diode SBD混載品

I _D (A)	V _{DSS} (V)	
	30 V	R _{DS(ON)} (mΩ)
35	TPCA8A11-H	3.6
40	TPCA8A10-H	3
51	TPCA8A09-H	2.3

● Package パッケージ

TPC8001-H

TP8	SOP-8 (new type)
TPC6	VS-6
TPC8	SOP-8 (conventional type)
TPCA8	SOP Advance (conventional type)
TPCC8	TSON Advance (conventional type)
TPCP8	PS-8
TPH	SOP Advance (new type)
TPN	TSON Advance (new type)
TPW	DSOP Advance

TK11S10N1L

A	TO-220SIS
E	TO-220
G	D2PAK
F	TO-220SM(W)
P	DPAK
S	DPAK+

For detailed information about individual MOSFETs, visit our website or see the SEMICONDUCTOR GENERAL CATALOG.

個別の製品の詳細につきましては、ウェブサイトまたは東芝半導体製品総覧表にてご確認ください。

Low On-Resistance Series

低オン抵抗シリーズ

As smartphones, tablet PCs and other mobile devices become more sophisticated and feature-rich, their battery drive circuits are becoming more versatile and densely packed. Consequently, MOSFETs with small form factors, low on-resistance, high current ratings, low capacitance and high permissible power dissipation are required. To meet these needs, Toshiba has developed new process and packaging technologies to realize MOSFETs ideal for high-performance power supply applications.

スマートフォンやタブレットPCなどに代表される携帯機器のバッテリー駆動回路では、機器が多機能・高機能になるにたがって、高性能化・高密度化が進んでいます。そのため、MOSFETには、小型・低オン抵抗・大電流・高許容損失といった特性が求められます。これらのニーズにお応えするため、プロセス技術とパッケージ技術の新規開発を進め、高性能な電源回路に貢献できるMOSFETを提案します。

■ Features 特長

Toshiba offers MOSFETs specifically optimized for on-resistance, which exhibit lower on-resistance than those for general-purpose switching power supply applications in the same generation.

低オン抵抗に特化することで、同一世代の汎用スイッチング電源対応シリーズと比較して、より低いオン抵抗を実現しています。

■ Package パッケージ

Toshiba has endeavored to reduce the MOSFET on-resistance by using the latest small-geometry process and improving package structures.

最先端の微細加工技術の導入とパッケージ構造の改善にて、オン抵抗の継続的削減を実現しています。

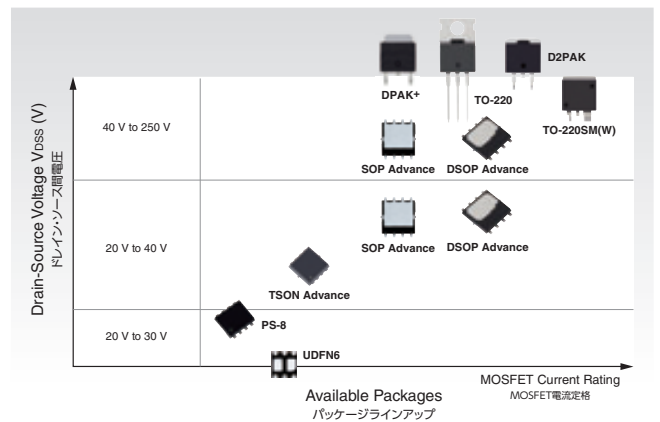
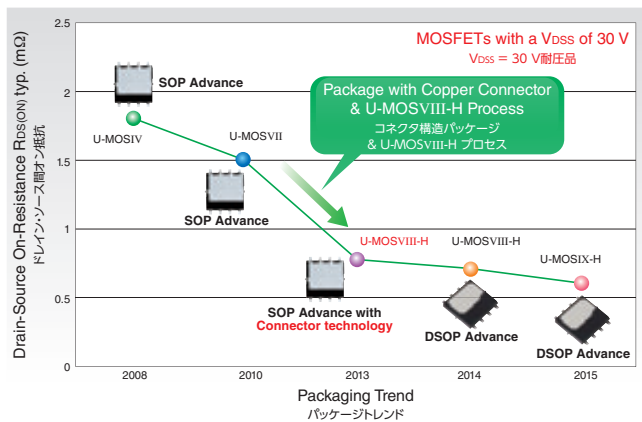
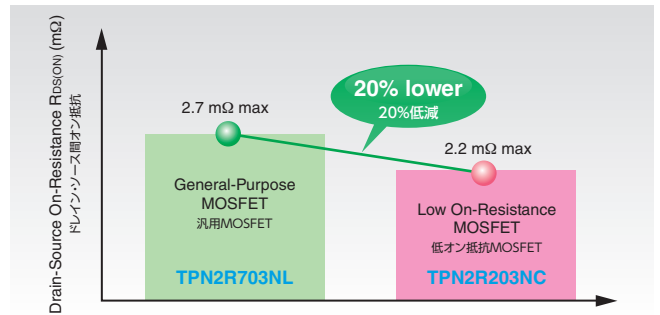

■ Double-sided cooling Package DSOP Advance 両面放熱パッケージ

The new device has a heat sink on both sides of the package to improve heat dissipation, making it possible to realize high-current operations in compact packages.

パッケージ両面にチップから熱を逃がすための金属板を配置することにより、効率的な放熱を可能にし、小型パッケージでの大電流化要求に応えます。

1. Heat is removed from both the top and bottom surfaces.

The top metal plate is connected to the source. The source cannot serve as an electrode to conduct electric current. Use it for heat removal purposes.

2. Same footprint dimensions as for existing SOP Advance

SOP Advance can be replaced by the new package without modifying an existing PCB layout.

1. 裏面/上面の両面から放熱します。

上面金属板はソースに接続していますが、ソースを電極として通電させることはできませんので、放熱用としてご使用下さい。

2. SOP Advanceパッケージ製品と裏面寸法(パッド寸法)が互換になっています。

既存のプリント基板のレイアウトでそのまま置き換えることが可能です。

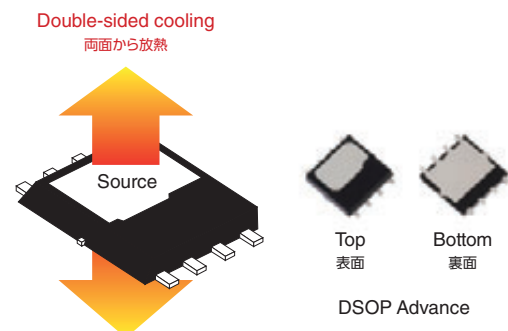

Product Selection Guide 製品セレクションガイド

Single Type (N-channel) シングルタイプ (Nチャンネル)

V _{DSS} (V)	R _{DS(ON)} max (mΩ)	UDFN6B	VS-8	VS-6	PS-8	TSON Advance	SOP Advance	SOP-8	DPAK+	TO-220SM(W)	TO-3P(N)
20	20 to 18		TPCF8003	TPC6012							
	6 to 5					TPCC8093					
30	24 to 23		TPCF8004	TPC6067							
	20 to 8	SSM6K504NU SSM6K513NU*						TPC8092			
	8 to 6					TPCC8074 TPN6R303NC		TPC8074 TPC8086			
	6 to 4					TPCC8073 TPN4R203NC		TPC8073 TPC8085 TPC8082			
	4 to 2					TPN2R503NC TPN2R203NC	TPCA8082 TPCA8081 TPCA8080 TPCA8088 TPCA8087	TPC8081 TPC8080 TPC8088 TPC8087 TPC8084			
	2 to 0.8										
33	7 to 6					TPCC8084		TPC8076			
	6 to 4					TPCC8076		TPC8075			
	4 to 2						TPCA8075 TPCA8078	TPC8078			
40	32 to 23				TPCP8011 TPCP8010						
	15 to 10	SSM6K514NU*			TPCP8009					TK20S04K3L TK35S04K3L	
	10 to 4					TPCC8069	TPCA8085			TK50S04K3L	TK70J04K3Z
	4 to 2									TK100F04K3 TK100F04K3L	TK75J04K3Z
60	60 to 40				TPCP8013					TK8S06K3L	
	40 to 20	SSM6K341NU**			TPCP8012					TK20S06K3L	
	20 to 15									TK30S06K3L	
	15 to 10					TPCC8070	TPCA8086			TK45S06K3L	
	6 to 4									TK80S06K3L	TK100F06K3 TK70J06K3
	4 to 2									TK130F06K3	
75	6 to 4								TK80F08K3		
100	69	SSM6K361NU**									

*: New Product **: Under Development
*: 新製品 **: 開発中

Single Type (P-channel) シングルタイプ (Pチャンネル)

V _{DSS} (V)	R _{DS(ON)} max (mΩ)	UDFN6B	VS-8	VS-6	PS-8	TSON Advance	SOP Advance	SOP-8	DPAK+	DPAK	TO-220SM(W)	TO-220SIS
-12	20 to 10	SSM6J512NU SSM6J505NU SSM6J511NU										
-20	110 to 100			TPC6130								
	60 to 40			TPC6113								
	40 to 20	SSN6J503NU SSM6J502NU	TPCF8105 TPCF8108	TPC6111								
	20 to 15	SSM6J501NU			TPCP8105	TPCC8136						
	10 to 8					TPCC8137						
	8 to 6					TPCC8138						
-30	6 to 4					TPN4R712MD						
	2 to 0.8						TPH1R712MD					
	60 to 40	SSM6J509NU**		TPC6110								
	40 to 20	SSM6J508NU**	TPCF8107		TPCP8106			TPC8129				
	20 to 15	SSM6J507NU				TPCC8131	TPCA8131					
	15 to 10					TPCC8103		TPC8125				
	10 to 8					TPCC8104	TPCA8109	TPC8126 TPC8123				
	8 to 6					TPCC8105		TPC8127				
-40	6 to 4						TPCA8128 TPCA8120 TPCA8121	TPC8128				
	4 to 2							TPC8120				
	60 to 40				TPCP8109			TPC8134	TJ10S04M3L			
	40 to 20							TPC8132	TJ20S04M3L	TJ15P04M3		
	20 to 15				TPCP8107							
	15 to 10					TPCC8106	TPCA8124	TPC8133				
	10 to 8								TJ40S04M3L			
-60	8 to 6							TPC8124				
	6 to 4						TPCA8122		TJ80S04M3L			
	4 to 2									TJ100F04M3L TJ200F04M3L		
	120 to 100				TPCP8111				TJ8S06M3L			
	60 to 40								TJ15S06M3L			
-100	40 to 20				TPCP8110	TPCC8107	TPCA8125		TJ30S06M3L			
	15 to 10						TPCA8123		TJ50S06M3L TJ60S06M3L			
	8 to 6									TJ100F06M3L		
	6 to 4									TJ150F06M3L		
-100	200 to 100											TJ9A10M3 TJ11A10M3
	100 to 60											TJ20A10M3

For detailed information about individual MOSFETs, visit our website or see the SEMICONDUCTOR GENERAL CATALOG.

** : Under Development
**: 開発中

個別の製品の詳細につきましては、ウェブサイトまたは東芝半導体製品総覧表にてご確認ください。

Small Package Series

小型パッケージシリーズ

Housed in a tiny package with a small footprint, MOSFETs of this series can be placed anywhere on a printed circuit board and thus help reduce the size of end-products. These MOSFETs are suitable for use as general-purpose switches in various drive circuits and communication lines.

小型パッケージに搭載することで、実装面積を削減し、機器の小型化に貢献します。各種の駆動回路や通信ラインの汎用スイッチとして、実装箇所を気にすることなく使用できます。

■ Features 特長

Fabricated using the latest trench process, MOSFETs of this series provide the industry's lowest-class on-resistance. Furthermore, process tuning is performed to achieve low-voltage operation. An integrated protection diode provides an improved trade-off between the chip size and ESD immunity.

最新のトレンチプロセスを使用し、業界最高水準の低オン抵抗特性をもった製品を提供します。また、プロセスチューニングを行い、低電圧駆動化を実現しています。チップ小型化に伴うESD耐量低下に関しては、保護ダイオード内蔵により、そのトレードオフを改善しました。

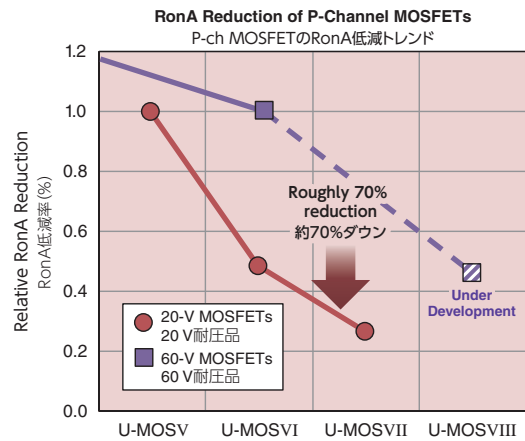
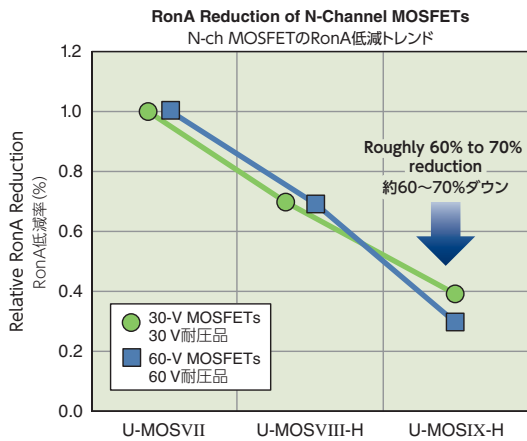

■ Package パッケージ

Extensive packaging options are available, ranging from a package measuring 3.0 mm x 3.0 mm to an ultra-small package measuring less than 1.0 mm x 1.0 mm. These packages feature a small form factor, low on-resistance and high permissible power dissipation.

3.0 x 3.0 mmから 1.0 x 1.0 mmクラス以下の超小型パッケージまで幅広いラインアップ製品を提供します。小型、低オン抵抗、高許容損失の特長があります。

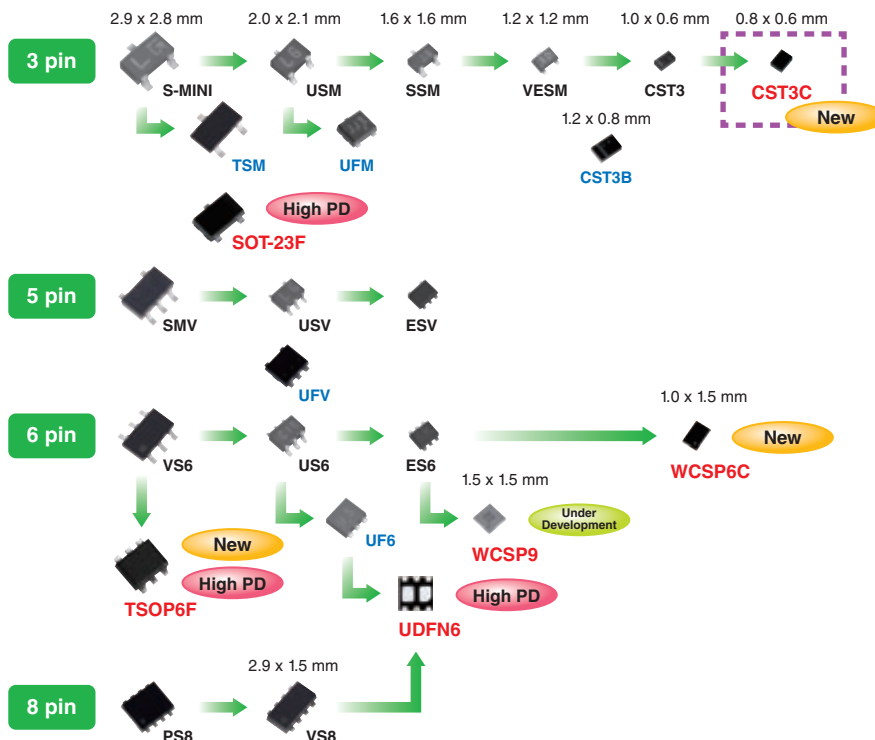

Semi-Power Type セミパワータイプ

■ Single N-ch (1) シングルNチャンネル (1)

Absolute Maximum Ratings 絶対最大定格			R _{DS(ON)} (mΩ)		Ciss (pF)	Package パッケージ				
V _{DSS} (V)	V _{GSS} (V)	I _D (A)	max	@ V _{GSl} (V)		CST3 SOT-883	CST3B	VESM SOT-723	WCSP6C	SSM SOT-416
12	±8	7	18	4.5	600					
20	±8	0.8	235	4.5	55			SSM3K56MFV*	SSM6K781G*	SSM3K56FS
	±8	1.4	235	4.5	55	SSM3K56ACT*				
40	±12	2	228	4.5	130		SSM3K59CTB*			

*: New Product
*: 新製品

■ Single N-ch (2) シングルNチャンネル (2)

Absolute Maximum Ratings 絶対最大定格			R _{DS(ON)} (mΩ)		Ciss (pF)	Package パッケージ					
V _{DSS} (V)	V _{GSS} (V)	I _D (A)	max	@ V _{GSl} (V)		ES6 SOT-563	UDFN6B	UFM	UF6	SOT-23F	TSOP6F
20	±10	2	126	4	195	SSM6K204FE		SSM3K122TU			
	±10		123	4	195						
	±10	3.2	55	4	400	SSM6K211FE			SSM6K404TU		
	±10		47	4.5	510						
	±10	4.2	48	4	400			SSM3K121TU			
	±10		28	4	1010			SSM3K123TU			
30	±10	10	28	4	1050				SSM6K403TU		
	±12		12	4.5	710				SSM6K411TU		
	±12	1.9	133	4	123	SSM6K208FE					
	±12		2	123	4	123					
	±12	2.2	100	4.5	245			SSM3K127TU			
	±12		100	4.5	245			SSM3K116TU			
	±20	3	140	4.5	126					SSM3K336R	
	±12		126	4	123					SSM3K329R	
	±12	4	56	4.5	200					SSM3K324R*	
	±20		56	4.5	200						
	±20	4.4	38.5	4.5	490				SSM6K406TU		
	±20		41.5	4.5	450			SSM3K131TU			
±20	6	42	4.5	436					SSM3K333R		
±20		56	4.5	340					SSM3K335R		
±20	9	26	4.5	620							
±20		26	4.5	620			SSM6K504NU*				
±20	15	12	4.5	1130			SSM6K513NU*			SSM6K803R**	
±20		12	4.5	1130							
38	±20	2	176	4.5	120				SSM3K337R		
40	±12	1.8	208	4.5	130	SSM6K217FE*					
	±12		198	4.5	130					SSM3K339R*	
60	±20	12	17.3	4.5	1110						
	±20		17.3	4.5	1110						
	±20	2	440	4	150			SSM3K2615TU*			
	±20		440	4	150				SSM6K407TU		
100	±20	2.5	145	4.5	235					SSM3K2615R*	
	±20		145	4.5	235					SSM3K318R*	
	±20	6	51	4.5	550					SSM3K341R*	
	±20		51	4.5	550			SSM6K341NU**			
100	±20	3.5	92	4.5	430						
	±20		92	4.5	430			SSM6K361NU**			

*: New Product **: Under Development
*: 新製品 **: 開発中

■ Single P-ch (1) シングルPチャンネル (1)







Absolute Maximum Ratings 絶対最大定格			R _{DS(ON)} (mΩ)		Ciss (pF)	Package パッケージ			
V _{DSS} (V)	V _{GSS} (V)	I _D (A)	max	@ V _{GSl} (V)		CST3 SOT-883	CST3B	VESM	WCSP6C
-20	±8	-0.8	390	4.5	100				
	±8	-1.4	390	4.5	100	SSM3J56ACT*		SSM3J56MFV	
	±8	-2	103	4.5	290		SSM3J46CTB		
	±12	-5	35	4.5	870				SSM6J771G*

*: New Product
*: 新製品

For detailed information about individual MOSFETs, visit our website or see the SEMICONDUCTOR GENERAL CATALOG.





個別の製品の詳細につきましては、ウェブサイトまたは東芝半導体製品総覧表にてご確認ください。

■ Single P-ch (2) シングルPチャンネル (2)

Absolute Maximum Ratings 絶対最大定格			R _{DS(ON)} (mΩ)		C _{iss} (pF)	Package パッケージ						
V _{DSS} (V)	V _{GSS} (V)	I _D (A)	max	@I _{VGSl} (V)		ES6 SOT-563 	UDFN6B 	UFM 	UF6 	SOT-23F 	S-Mini SOT-346 	TSOP6F 
-12	±8	-4.8	32	4.5	1040	SSM6J216FE						
	±6	-5.4	17	4.5	2700			SSM3J132TU				
	±10	-6	20.2	4.5	1400					SSM3J338R*		
	±10	-10	18.7	4.5	1400		SSM6J512NU*					
	±6	-12	12	4.5	2700		SSM6J505NU					
	±10	-14	10	4.5	3350		SSM6J511NU*					
-20	±8	-2	150	4.5	270						SSM3J325F	
	±12	-2	136	4.5	210						SSM3J352F*	
	±10	-2.5	64	4.5	800				SSM6J50TU			
	±8	-2.6	103	4.5	290	SSM6J213FE						
	±8	-3	103	4.5	270			SSM3J135TU				
	±8	-3.2	93	4.5	290			SSM3J134TU				
	±8	-3.4	59	4.5	630	SSM6J215FE						
	±8	-3.9	93	4.5	290					SSM3J327R		
	±8	-4	55	4.5	630					SSM3J331R		
	±8	-4	40.7	4.5	970	SSM6J212FE						
	±8	-4	42.7	4.5	840				SSM6J412TU*			
	±8	-4.4	25.8	4.5	1800			SSM3J130TU				
	±8	-5.5	29.8	4.5	840			SSM3J133TU				
	±8	-6	29.8	4.5	840					SSM3J328R		SSM8J801R**
	±8	-6	23.1	4.5	1800		SSM6J502NU					
	±8	-6	32.4	4.5	840		SSM6J503NU					
	±8	-6	22.5	4.5	1650				SSM6J414TU			
	-30	±8	-10	15.3	4.5	2600		SSM6J501NU				
±20		-1.1	790	4	86			SSM3J112TU				
±20		-1.4	480	4	137			SSM3J118TU				
±20		-1.4	491	4	137	SSM6J207FE						
±20		-2	225	4	280			SSM3J117TU				
±20		-2	270	4.5	175						SSM3J353F**	
±20		-2	225	4	280							
±20		-2.1	393	4	120				SSM6J402TU			
±20		-2.5	145	4	730				SSM6J410TU			
±12		-3.6	57	4.5	560	SSM6J214FE			SSM6J401TU			
±20		-4	105	4.5	280					SSM3J334R		
±20		-4	66	4.5	600					SSM3J340R*		
±20		-4	66	4.5	600		SSN6J509NU**					
-60		±12	-6	50	4.5	560					SSM3J332R	
	±20	-6	40	4.5	1083		SSM6J508NU**					
	±20	-6	40	4.5	1150		SSM6J507NU*					
	±20	-10	28	4.5	1150							
	±20	-10	28	4.5	1150					SSM3J356R*		
	±20	-10	28	4.5	1150					SSM3J351R**		

*: New Product **: Under Development
*: 新製品 **: 開発中









■ Dual channel/Complementary デュアルチャンネル/コンプリメンタリ

Polarity 極性	Absolute Maximum Ratings 絶対最大定格			R _{DS(ON)} (mΩ)		C _{iss} (pF)	Package パッケージ					
	V _{DSS} (V)	V _{GSS} (V)	I _D (A)	max	@I _{VGSl} (V)		ES6 SOT-563 	UDFN6B 	UF6 	UFM 	UFV 	
N-ch x 2	20	±8	0.8	235	4.5	55	SSM6N56FE*					
		±8	0.8	95	4.5	215			SSM6N62TU**			
		±10	1.6	119	4	260			SSM6N39TU			
	30	±8	4	33	4.5	410		SSM6N61NU*				
		±12	0.5	145	4.5	245			SSM6N24TU			
		±20	1.6	182	4	180			SSM6N40TU			
P-ch x 2	-20	±8	4	64	4.5	280			SSM6N55NU			
		±12	4	39.1	4.5	310			SSM6N57NU			
		±12	4	84	4.5	129			SSM6N58NU			
	-30	±8	-0.72	300	4.5	110	SSM6P41FE					
		±8	-1.2	228	2.5	331			SSM6P54TU			
		±8	-1.5	213	4	250			SSM6P39TU			
N-ch + P-ch	20	±8	-4	95	4.5	290			SSM6P47NU			
		±12	-4	56	4.5	480			SSM6P49NU			
		±20	-1.4	403	4	120				SSM6P40TU		
	-20	±8	0.8	240	4.5	90	SSM6L14FE					
		±8	-0.72	300	4.5	110						
		±10	1.6	119	4	260						
		±8	-1.5	213	4	250				SSM6L39TU		
		±8	4	33	4.5	410						
		±12	-4	56	4.5	480			SSM6L61NU*			
N-ch + SBD	20	±12	0.5	145	4.5	245						
		±20	1.6	182	4	180						
		±12	-0.5	260	4	218				SSM6L12TU		
	30	±20	1.6	182	4	180						
		±20	-1.4	403	4	120				SSM6L40TU		
		±12	1.5	160	4	125						SSM5H08TU
40	±10	2.4	65	4	200						SSM5H90ATU	
	±20	1.4	450	4	106						SSM5H01TU	
	±12	1.9	133	4	123						SSM5H11TU	
P-ch + SBD	-12	±12	2	198	4.5	130		SSM6H19NU*				SSM5H16TU
		±12	-1	160	4	310						SSM5G02TU
		±8	-1.5	130	4	550						SSM5G09TU
N-ch + ZD	34	±8	-2	112	4.5	270			SSM6G18NU			
		±20	-1.4	403	4	120						SSM5G11TU
		±20	2	280	4.5	119						SSM3H137TU*

*: New Product **: Under Development
*: 新製品 **: 開発中





Small-Signal Standard Type 小信号スタンダードタイプ

■ Single N-ch/P-ch シングル Nチャンネル/Pチャンネル

Polarity 極性	Absolute Maximum Ratings 絶対最大定格			R _{DS(ON)} (Ω)		Package パッケージ								
						CST3C	CST3 SOT-883	VESM SOT-723	SSM SOT-416	UFM	USM SOT-323	SOT23	S-Mini	
	V _{DSS} (V)	V _{GSS} (V)	I _D (A)	max	@ V _{GSL} (V)									
N-ch	20	±10	0.18	3	4			SSM3K35CT	SSM3K35MFV	SSM3K35FS				
		±10	0.2	2.2	4.5			SSM3K37CT		SSM3K37FS				
		±10	0.25	1.1	4.5	SSM3K35CTC*								
		±10		2.2	4.5			SSM3K37MFV						
		±10	0.5	0.66	4.5			SSM3K36MFV	SSM3K36FS	SSM3K36TU				
		±8	0.8	0.235	4.5			SSM3K56MFV*	SSM3K56FS					
	30	±8	1.4	0.235	4.5			SSM3K56ACT*						
		±20	0.1	3.6	4	SSM3K15ACT*	SSM3K15ACT	SSM3K15AMFV	SSM3K15AFS		SSM3K15AFU			
		±20		4	4			SSM3K44MFV	SSM3K44FS			SSM3K15F		
		±20	0.4	1.2	4						SSM3K09FU			
		±7	0.1	20	4						SSM3K17FU			
		60	±20	0.15	4.7	4.5	SSM3K72CTC*							
±20	0.17		4.7	4.5				SSM3K72CFV*		SSM3K7002CFU*				
±20	0.2		4.7	4.5							T2N7002AK*			
±20	0.4		1.75	4.5			SSM3K72KCT*	SSM3K72KFS*		SSM3K7002KFU*		SSM3K7002KF*		
±20	0.4		1.75	4.5							T2N7002BK*			
±10	-0.1		8	4			SSM3J35CT	SSM3J35MFV	SSM3J35FS					
P-ch	-20	±10	-0.25	1.5	4.5	SSM3J35CTC*								
		±8	-0.33	1.31	4.5			SSM3J36MFV	SSM3J36FS	SSM3J36TU				
		±8	-0.8	0.39	4.5			SSM3J56MFV						
	-30	±8	-1.4	0.39	4.5			SSM3J56ACT*						
		±20	-0.1	12	4			SSM3J15CT	SSM3J15FV	SSM3J15FS		SSM3J15FU	SSM3J15F	
		±20	-0.2	4.2	4						SSM3J09FU			
-60	±20	-0.2	2	10								SSM3J168F**		

*: New Product **: Under Development
*: 新製品 **: 開発中

■ Dual N-chx2/P-chx2/N-ch+P-ch デュアル Nチャンネル×2/Pチャンネル×2/Nチャンネル+Pチャンネル

Polarity 極性	Absolute Maximum Ratings 絶対最大定格			R _{DS(ON)} (Ω)		Package パッケージ					Constituent Devices 構成デバイス	
						ESV SOT-553	ES6 SOT-563	USV SOT-353	UF6	US6 SOT-363		
	V _{DSS} (V)	V _{GSS} (V)	I _D (A)	max	@ V _{GSL} (V)							
N-ch x 2	20	±10	0.1	3	4	SSM5N16FE		SSM5N16FU			SSM3K16FU x 2	
		±10	0.18	3	4		SSM6N35FE			SSM6N35FU	SSM3K35FS x 2	
		±10	0.25	2.2	4.5		SSM6N37FE			SSM6N37FU	SSM3K37MFV x 2	
		±10	0.5	0.66	4.5		SSM6N36FE		SSM6N36TU	SSM6N43FU	SSM3K36FS x 2	
		±8	0.8	0.235	4.5		SSM6N56FE				SSM3K56FS x 2	
		±20	0.1	3.6	4						SSM6N15AFU	SSM6N56FE x 2
	±20	4		4	SSM5N15FE		SSM5N15FU				SSM3K15FU x 2	
	30	±20	0.4	4	4		SSM6N44FE			SSM6N44FU	SSM3K44FS x 2	
		±20		1.2	4					SSM6N09FU	SSM3K09FU x 2	
		±7	0.1	20	4					SSM6N17FU	SSM3K17FU x 2	
		60	±20	0.17	4.7	4.5					SSM6N7002CFU*	T2N7002AK x 2
			±20	0.3	1.75	4.5					SSM6N7002KFU*	T2N7002BK x 2
P-ch x 2		-20	±10	-0.1	8	4	SSM5P16FE	SSM6P16FE	SSM5P16FU		SSM6P16FU	SSM3J16FU x 2
	±10		-0.33	8	4		SSM6P35FE			SSM6P35FU	SSM3J35FS x 2	
	±8			1.31	4.5		SSM6P36FE		SSM6P36TU		SSM3J36FS x 2	
	-30	±20	-0.1	12	4	SSM5P15FE	SSM6P15FE	SSM5P15FU		SSM6P15FU	SSM3J15FU x 2	
		±20	-0.2	4.2	4					SSM6P09FU	SSM3J09FU x 2	
		±20	0.18	3	4						SSM3K35FS	
N-ch + P-ch	-20	±10	-0.1	8	4		SSM6L35FE			SSM6L35FU	SSM3K35FS +SSM3J35FS	
	20	±10	0.5	0.66	4.5						SSM3K36FS	
	-20	±8	-0.33	1.31	4.5		SSM6L36FE		SSM6L36TU		SSM3J36FS	
	30	±20	0.4	1.2	4						SSM3K09FU	
	-30	±20	-0.2	4.2	4					SSM6L09FU	SSM3J09FU +SSM3J09FU	

*: New Product **: Under Development
*: 新製品 **: 開発中

DTMOS Series

DTMOS シリーズ

Power MOSFETs are indispensable for converters, inverters and other switching power supplies. DTMOS is a power MOSFET series with a superjunction structure that feature high current-switching capability. With a V_{DS} of 600 V or so, DTMOS is suitable for mid- to high-voltage applications.

コンバータやインバータなどのスイッチング電源に欠かせないパワーMOSFETです。スーパー Junction 構造により大電流化を図っています。耐圧 600 V を中心としたラインアップで、中高耐圧アプリケーションに適しています。

Fourth-Generation Super-Junction DTMOS Series (DTMOSIV)

第4世代 スーパー Junction DTMOS シリーズ (DTMOSIV)

Fabricated using a state-of-the-art single-epitaxial process, the DTMOSIV series exhibits an R_{onA} lower than $15 \text{ m}\Omega \cdot \text{cm}^2$. The reduction in R_{onA} , a performance index for MOSFETs, directly translates to a reduction in conduction loss, which helps improve the efficiency and reduce the size of power supplies.

最新のシングルエピタキシャルプロセスの採用により、性能指標 R_{onA} が $15 \text{ m}\Omega \cdot \text{cm}^2$ を下回る性能を実現しています。 R_{onA} の性能向上により導通損失を抑え、電源機器の効率改善を実現すると共に、小型化に大きく貢献します。

Product Lineup 製品のラインアップ展開

Toshiba is planning to expand its MOSFET portfolio to meet diverse customer needs.

ご要望に合わせて、さまざまなラインアップ展開を計画中です。

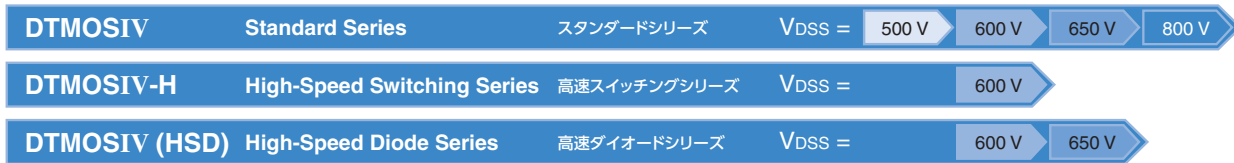

DTMOSIV-H High-Speed Switching Series 高速スイッチングシリーズ

The DTMOSIV-H Series features high-speed switching performance and thus low switching loss. It provides gate-drain capacitance, Q_{gd} , approximately 30% lower than standard MOSFET series.

高速スイッチング特性により、低スイッチング損失を実現したシリーズです。スタンダード品に比べて、 Q_{gd} (ゲート・ドレイン間容量) を約30%削減しています。

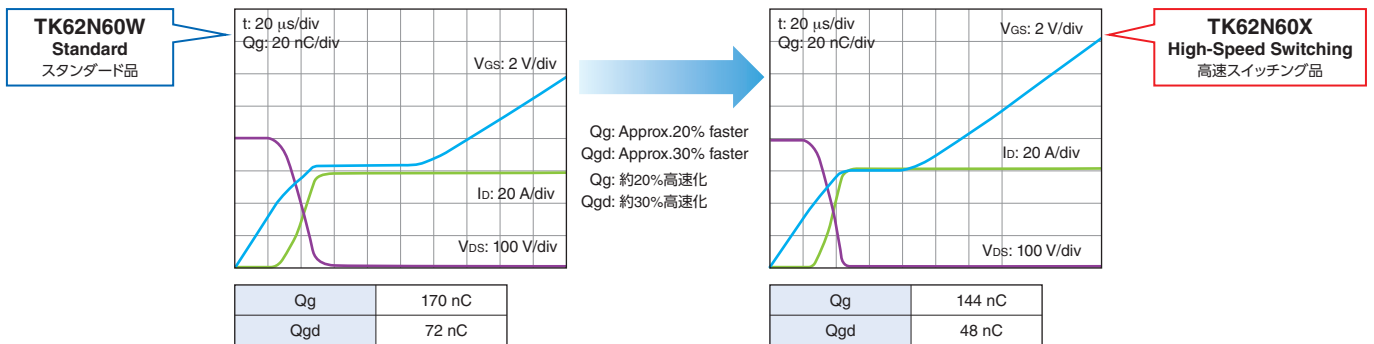

Dynamic Input/Output Characteristics: Qg Curves
ダイナミック入出力特性: Qg 波形

DTMOSIV (HSD) High-Speed Diode Series 高速ダイオードシリーズ

The DTMOSIV (HSD) Series has a parasitic diode faster than that of the standard series. It delivers reverse recovery time more than 70% shorter than the standard series, and thus significantly reduces the recovery loss incurred by the parasitic diode.

MOSFET内蔵寄生ダイオードの高速化を実現したシリーズです。スタンダード品に比べて逆回復時間が70%以上短いため、寄生ダイオードで発生するリカバリ損失を大幅に低減させることができます。

DTMOSIV	Standard スタンダード品	High-Speed Diode 高速ダイオード品
Part Number 品番	TK16A60W	TK16A60W5
Rating 定格	600 V/15.8 A	600 V/15.8 A
On-Resistance オン抵抗	0.19 Ω Max	0.23 Ω Max
Reverse Recovery Time: t_{rr} リカバリ時間	280 ns	100 ns

Comparisons of Typical Performance Characteristics
代表製品特性比較表

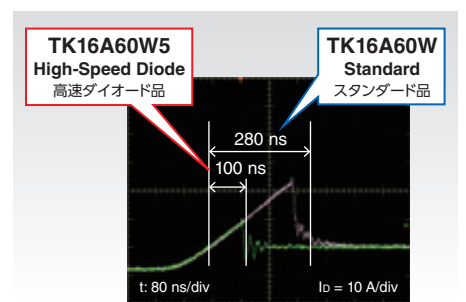

Reverse-Recovery Waveform of the Parasitic Diode
寄生ダイオードリカバリ時波形

* Test condition: $V_{DD} = 400 \text{ V}$, $I_{DR} = 7.9 \text{ A}$, $T_c = 25^\circ \text{C}$
* 測定条件: $V_{DD} = 400 \text{ V}$, $I_{DR} = 7.9 \text{ A}$, $T_c = 25^\circ \text{C}$

Product Selection Guide 製品セレクションガイド

DTMOSIV Standard Series スタンダードシリーズ

V _{DSS} (V)	R _{DS(ON)} max (Ω)	Package パッケージ										
		DFN8x8	DPAK	D2PAK	IPAK	TO-220SIS	I2PAK	TO-220	TO-3P(N)	TO-247	TO-3P(L)	
500	0.38					TK10A50W						
	0.30					TK12A50W						
	0.19					TK19A50W						
600	0.9		TK5P60W		TK5Q60W	TK5A60W						
	0.82 to 0.75		TK6P60W		TK6Q60W	TK6A60W						
	0.6		TK7P60W		TK7Q60W	TK7A60W						
	0.5		TK8P60W		TK8Q60W	TK8A60W						
	0.43 to 0.38	TK10V60W	TK10P60W		TK10Q60W	TK10A60W		TK10E60W				
	0.34 to 0.30	TK12V60W	TK12P60W		TK12Q60W	TK12A60W		TK12E60W	TK12J60W			
	0.19	TK16V60W		TK16G60W		TK16A60W	TK16C60W	TK16E60W	TK16J60W	TK16N60W		
	0.17 to 0.155	TK20V60W		TK20G60W		TK20A60W	TK20C60W	TK20E60W	TK20J60W	TK20N60W		
	0.098 to 0.088	TK31V60W				TK31A60W		TK31E60W	TK31J60W	TK31N60W		
	0.065					TK39A60W			TK39J60W	TK39N60W		
	0.04								TK62J60W	TK62N60W		
	0.018											TK100L60W
650	1.22 to 1.20		TK5P65W		TK5Q65W	TK5A65W						
	1.05 to 1.0		TK6P65W		TK6Q65W	TK6A65W						
	0.8 to 0.78		TK7P65W		TK7Q65W	TK7A65W						
	0.67 to 0.65		TK8P65W		TK8Q65W	TK8A65W						
	0.56 to 0.50		TK9P65W		TK9Q65W	TK9A65W						
	0.44 to 0.39		TK11P65W		TK11Q65W	TK11A65W						
	0.28 to 0.25	TK14V65W*		TK14G65W		TK14A65W	TK14C65W	TK14E65W		TK14N65W		
	0.21 to 0.20	TK17V65W*				TK17A65W	TK17C65W	TK17E65W		TK17N65W		
	0.12 to 0.11	TK28V65W*				TK28A65W		TK28E65W**		TK28N65W		
	0.08					TK35A65W				TK35N65W		
0.055									TK49N65W			
800	2.25		TK3P80W**		TK3Q80W**							
	1.05		TK6P80W**		TK6Q80W**							
	0.9					TK7A80W**		TK7E80W**				
	0.65 to 0.55					TK10A80W**		TK10E80W**				
	0.45					TK12A80W*		TK12E80W**		TK12N80W**		
0.29					TK17A80W		TK17E80W**		TK17N80W**			

*: New Product **: Under Development
*: 新製品 **: 開発中

DTMOSIV-H High-Speed Switching Series 高速スイッチングシリーズ

V _{DSS} (V)	R _{DS(ON)} max (Ω)	Package パッケージ				
		DFN8x8	TO-220SIS	TO-220	TO-247	TO-247-4L
600	0.135 to 0.125	TK25V60X	TK25A60X	TK25E60X	TK25N60X	TK25Z60X*
	0.098 to 0.088	TK31V60X		TK31E60X	TK31N60X	TK31Z60X*
	0.065				TK39N60X	TK39Z60X*
	0.04				TK62N60X	TK62Z60X*

*: New Product
*: 新製品

DTMOSIV (HSD) High-Speed Diode Series 高速ダイオードシリーズ

V _{DSS} (V)	R _{DS(ON)} max (Ω)	Package パッケージ								
		DFN8x8	DPAK	D2PAK	TO-220SIS	I2PAK	TO-220	TO-3P(N)	TO-247	
600	0.99 to 0.95		TK5P60W5**		TK5A60W5*					
	0.67 to 0.65		TK7P60W5		TK7A60W5					
	0.56 to 0.54		TK8P60W5*		TK8A60W5					
	0.45				TK10A60W5					
	0.245 to 0.23	TK16V60W5		TK16G60W5	TK16A60W5		TK16E60W5	TK16J60W5	TK16N60W5	
	0.19 to 0.175	TK20V60W5			TK20A60W5		TK20E60W5	TK20J60W5	TK20N60W5	
	0.15 to 0.14	TK25V60X5			TK25A60X5		TK25E60X5		TK25N60X5	
	0.109 to 0.099	TK31V60W5						TK31J60W5	TK31N60W5	
650	0.074						TK39J60W5	TK39N60W5		
	0.045						TK62J60W5	TK62N60W5		
	0.3			TK14G65W5	TK14A65W5	TK14C65W5	TK14E65W5		TK14N65W5	
	0.23				TK17A65W5					
	0.17 to 0.16	TK22V65X5**			TK22A65X5**					
	0.14 to 0.13	TK28V65X5**							TK28N65W5	
800	0.095				TK35A65W5				TK35N65W5	
	0.057								TK49N65W5	

*: New Product
*: 新製品
**: Under Development
**: 開発中

For detailed information about individual MOSFETs, visit our website or see the SEMICONDUCTOR GENERAL CATALOG.
個別の製品の詳細につきましては、ウェブサイトまたは東芝半導体製品総覧表にてご確認ください。

π-MOS Series

π-MOS シリーズ

The π-MOSVII Series, the latest addition to our π-MOS portfolio, features reduced capacitance by virtue of the optimized chip design. The π-MOSVII Series has significantly expanded our MOS product lineup.

チップデザインの最適化により、容量特性を低減したπ-MOSの最新シリーズです。ラインアップを大幅に拡充しました。

π-MOSVII Series (V_{DS} = 400 V to 650 V) π-MOSVII シリーズ

■ Features 特長

- Delivers approximately 40% lower total gate charge, Q_g, than π-MOSVI.
- Available in 50 V steps of V_{DS} and in finer steps of R_{DS(ON)}.
- Rated avalanche and reverse recovery current capabilities.
- π-MOSVIIに比べて、Q_g(ゲート入力電荷量)を約40%低減。
- 耐圧の50 Vステップ化、および、オン抵抗の細分化によるラインアップの拡充。
- アバランシェ耐量、逆リカバリ耐量の定格電流保証。

■ Performance Comparisons Between π-MOSVII and π-MOSVI Devices (600 V/10 A)

新世代π-MOSVIIシリーズと従来のπ-MOSVIシリーズとの特性比較 (600 V/10 A定格品)

Characteristic 項目	Symbol 記号	Test Conditions 測定条件	π-MOSVII			π-MOSVI			Unit 単位
			min	typ.	max	min	typ.	max	
Gate leakage current ゲート漏れ電流	I _{GSS}	V _{GS} condition*, V _{DS} = 0 V	-	-	±1	-	-	±10	μA
Drain cut-off current ドレイン遮断電流	I _{DSS}	V _{DS} = 600 V, V _{GS} = 0 V	-	-	10	-	-	100	μA
Drain-source breakdown voltage ドレイン・ソース間降伏電圧	V _{(BR)DSS}	I _D = 10 mA, V _{GS} = 0 V	600	-	-	600	-	-	V
Gate threshold voltage ゲートしきり値電圧	V _{th}	V _{DS} = 10 V, I _D = 1 mA	2.0	-	4.0	2.0	-	4.0	V
Drain-source on-resistance ドレイン・ソース間 オン抵抗	R _{DS(ON)}	V _{GS} = 10 V, I _D = 5 A	-	-	0.75	-	-	0.75	Ω
Total gate charge ゲート入力電荷量	Q _g	V _{DD} = 400 V, V _{GS} = 10 V, I _D = 10 A	-	25	-	42	-	-	nC
Diode forward voltage 順電圧(ダイオード)	V _{DSF}	I _{DR} = 10 A, V _{GS} = 0 V	-	-	-1.7	-	-	-1.7	V

* Test Conditions: V_{GS} = ±30 V (TK10A60D), V_{GS} = ±25 V (2SK3569)

* 測定条件: V_{GS} = ±30 V (TK10A60D), V_{GS} = ±25 V (2SK3569)

■ Efficiency Test Circuit 効率評価

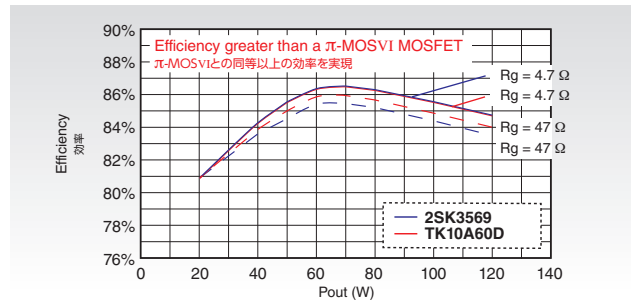
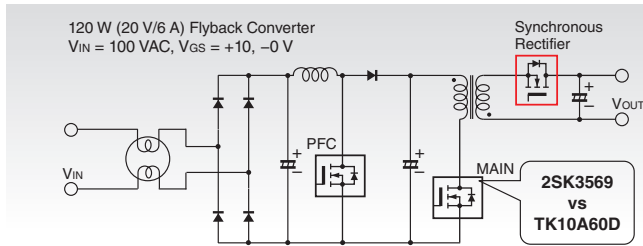

π-MOSVIII Series (V_{DS} = 800 V to 900 V) π-MOSVIII シリーズ

■ Features 特長

- Exhibits approximately 25% lower total gate charge, Q_g, than π-MOSVII (rated at 800 V to 900 V).
- Guarantees avalanche and reverse recovery ruggedness as current ratings.
- π-MOSVIII (800 V~900 V)に比べて、Q_g(ゲート入力電荷量)を約25%低減。
- アバランシェ耐量、リパースリカバリ耐量の定格電流保証。

■ Switching Waveforms スイッチング波形

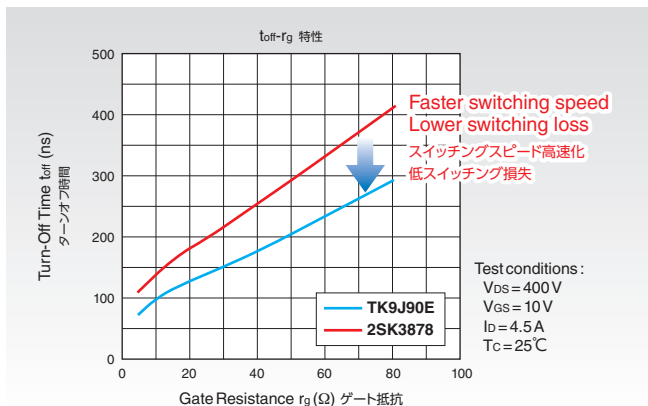

■ Comparisons of Total Gate Charge (Q_g)

Q_g (ゲート入力電荷量) 特性比較

Provides approx. 25% lower Q_g than the previous generation and thus reduces switching loss

前世代に比べて、Q_gを約25% 低減、スイッチング時の損失低減。

Gen. 世代	π-MOSIV	π-MOSVIII
Part Number 品番	2SK3878	TK9J90E
Q _g	60nC (@ V _{GS} = 10 V)	46nC (@ V _{GS} = 10 V)
V _{GS} -Q _g , V _{DS} -Q _g Waveforms V _{GS} -Q _g , V _{DS} -Q _g 波形		

Product Selection Guide 製品セレクションガイド

Id (A)	V _{DSS} (V)											
	200	R _{DS(ON)} (Ω)	250	R _{DS(ON)} (Ω)	300	R _{DS(ON)} (Ω)	450	R _{DS(ON)} (Ω)	500	R _{DS(ON)} (Ω)	525	R _{DS(ON)} (Ω)
3									TK3P50D	3		
4									TK4A50D TK4P50D	2 2	TK4A53D	1.7
4.5							TK5A45DA	1.75				
5									TK5A50D TK5P50D	1.5 1.5	TK5A53D TK5P53D	1.5 1.5
5.5							TK6A45DA	1.35				
6									TK6A50D	1.4	TK6A53D TK6P53D	1.3 1.3
6.5							TK7A45DA	1.2				
7									TK7A50D TK7P50D	1.22 1.22		
7.5			TK8A25DA TK8P25DA	0.5 0.5			TK8A45DA	1.1	TK8A50DA	1.04		
8							TK8A45D	0.9	TK8A50D	0.85		
8.5	TK9A20DA	0.4										
9							TK9A45D	0.77				
10									TK10A50D	0.72		
11							TK11A45D	0.62	TK11A50D	0.6		
12							TK12A45D	0.52	TK12A50D	0.52	TK12A53D	0.58
12.5									TK13A50DA	0.47		
13			TK13A25D TK13E25D TK13P25D	0.25 0.25 0.25			TK13A45D	0.46	TK13A50D	0.4		
13.5							TK14A45DA	0.41				
14							TK14A45D	0.34				
15	TK15A20D	0.18							TK15A50D TK15J50D	0.3 0.4		
16							TK16A45D	0.27				
17			TK17A25D	0.15								
18					TK18A30D	0.139			TK18A50D	0.27		
19							TK19A45D	0.25				
20	TK20A20D	0.109	TK20A25D	0.1					TK20J50D	0.27		
25	TK25A20D	0.07										
30			TK30J25D	0.06								
40	TK40J20D	0.044										
50					TK50J30D	0.052						
60			TK60J25D	0.038								
70	TK70J20D	0.027										

Id (A)	V _{DSS} (V)									
	550	R _{DS(ON)} (Ω)	600	R _{DS(ON)} (Ω)	650	R _{DS(ON)} (Ω)	800	R _{DS(ON)} (Ω)	900	R _{DS(ON)} (Ω)
1									TK1Q90A	9
2			TK2P60D TK2Q60D	4.3 4.3	TK2A65D	3.26			TK2P90E	5.9
2.5			TK3A60DA	2.8	TK3A65DA	2.51			2SK3566 TK3A90E*	6.4 4.6
3					TK3A65D	2.25	TK3P80E	4.9	2SK3564	4.3
3.5	TK4A55DA TK4P55DA	2.45 2.45	TK4A60DA TK4P60DA TK4Q60DA	2.2 2.2 2.2	TK4A65DA	1.9				
3.7			TK4A60DB TK4P60DB	2 2						
4	TK4A55D TK4P55D	1.88 1.88	TK4A60D TK4P60D	1.7 1.7			TK4A80E*	3.5	2SK3798	3.5
4.5					TK5A65DA	1.67			TK5A90E*	3.1
5	TK5A55D	1.7	TK5A60D	1.43	TK5A65D	1.43	TK5A80E*	2.4		
5.5	TK6A55DA	1.48								
6			TK6A60D	1.25	TK6A65D	1.11	TK6A80E	1.7		
7	TK7A55D	1.25			TK7A65D	0.98	2SK3633	1.7	TK7A90E TK7J90E	2 2
7.5	TK8A55DA	1.07	TK8A60DA	1						
8					TK8A65D	0.84				
8.5	TK9A55DA	0.86								
9			TK9A60D	0.83					TK9A90E TK9J90E	1.3 1.3
10	TK10A55D	0.72	TK10A60D	0.75			TK10A80E TK10J80E	1 1		
11	TK11A55D	0.63	TK11A60D	0.65	TK11A65D	0.7				
12	TK12A55D TK12J55D	0.57 0.57	TK12A60D	0.55	TK12A65D	0.54				
12.5	TK13A55DA	0.48								
13			TK13A60D	0.43	TK13A65D	0.47			2SK4207	0.95
14	TK14A55D	0.37								
15			TK15A60D	0.37						
16	TK16A55D TK16J55D	0.33 0.37								
19	TK19J55D	0.33								

*: New Product
*: 新製品

● Package パッケージ

TK20A20D

A	TO-220SIS	2SK3564	TO-220SIS
E	TO-220	2SK3566	
J	TO-3P(N)	2SK3798	
M	TO-3P(N)IS	2SK3633	TO-3P(N)
P	New PW-Mold/DPAK	2SK4207	
Q	New PW-Mold2		

For detailed information about individual MOSFETs, visit our website or see the SEMICONDUCTOR GENERAL CATALOG.

個別の製品の詳細につきましては、ウェブサイトまたは東芝半導体製品総覧表にてご確認ください。

Automotive MOSFETs

車載 MOSFET

Toshiba offers an extensive line of power devices such as power MOSFETs for various automotive applications, including 12-V battery and motor control systems. The combination of low-ON-resistance and fast switching speed makes Toshiba's power MOSFETs an ideal solution for reducing system losses, thereby contributing to the energy-saving of automotive applications.

東芝パワーMOSFETは、低オン抵抗と高速スイッチングにより、セットの損失を低減、車載用アプリケーションの省エネに貢献します。12Vバッテリーシステム・モータコントロール用をはじめ、多様な車載用途に向け、豊富なラインアップで提供します。

■ Features 特長

- Reduced RonA due to the small-geometry trench process.
- The DPAK+ and TO-220SM(W) Series provide a current drive capability approx. twice that of their predecessors due to the use of a Cu connector structure.
- Expanding portfolio of MOSFETs qualified up to 175°C according to AEC-Q101.
- For applications rated at 60 A or less, expanding portfolio of power MOSFETs in SOP packages (SOP Advance, TSON Advance, PS-8), which have been well proven for consumer applications.
- All devices are tested and guaranteed for avalanche breakdown protection.
- Zener diode between gate and source for ESD protection (except some devices).

- * 微細トレンチ加工技術の開発により、従来デザインに比べ、低RonAを実現。
- * DPAK+/TO-220SM(W)パッケージは、Cuコネクタ構造を採用し、従来比約2倍の大電流通電能力を実現。
- * 175°C保証のAEC-Q101に適合したラインアップを充実。
- * 60 A以下の用途向けに、民生用途で実績の高いSOP系パッケージラインアップを充実(SOP Advance, TSON Advance, PS-8)。
- * 全数アバランシェ耐量試験を実施。
- * 静電破壊レベル向上のために、ゲートソース間ツェナーダイオード(ZD)を内蔵(一部製品は除く)。

■ Low On-Resistance 低オン抵抗の実現

Industry's lowest ON-resistance due to the combined use a small-geometry trench structure and a Cu connector.

トレンチ微細加工技術と、Cuコネクタ結合の融合により、業界トップクラスの低オン抵抗を実現しています。

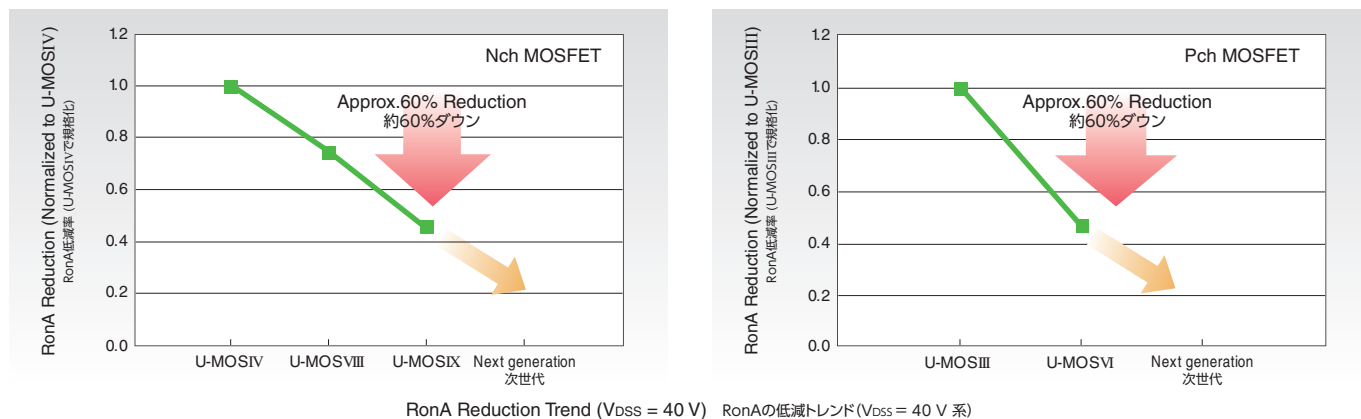

■ Packaging Trend パッケージ技術のトレンド

Increased current density due Cu clamp structure

Cuクランプ構造を採用することにより、電流密度をアップしています。

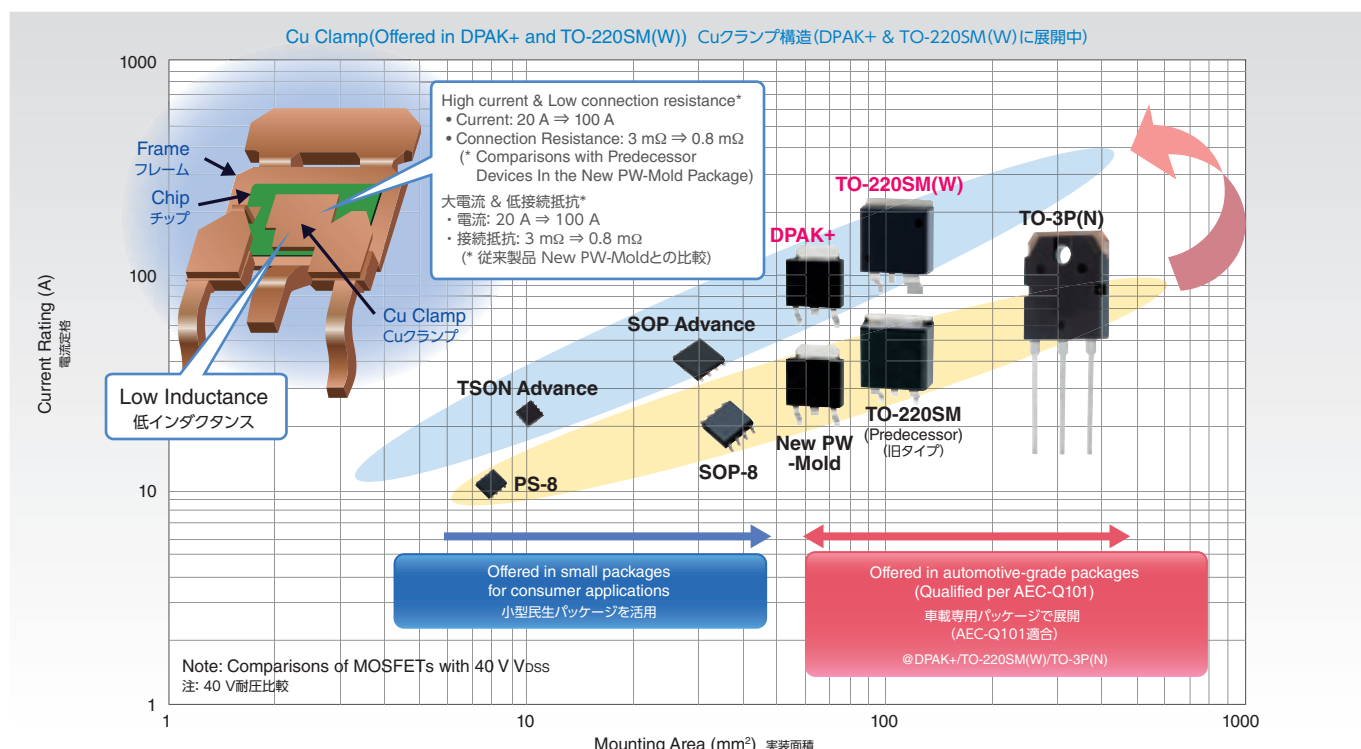

Product Selection Guide 製品セレクションガイド

U-MOS Series for Automotive Applications 車載対応 U-MOSシリーズ

Fabricated using a trench structure, the U-MOS Series realizes high integration density and thus low on-resistance.

トレンチ構造技術を採用して、高集積化を実現した低オン抵抗シリーズです。

	V _{DSS} (V)	R _{DS(ON)} Max (mΩ) @ I _{VGS1} = 10 V	Package パッケージ				Tch (°C)	Series シリーズ	
			DPAK+	TO-220SM(W)	D2PAK+	TO-220SIS			
N-ch	40	18 to 10	TK15S04N1L ^{(1)*} TK20S04K3L ⁽¹⁾	TK35S04K3L ⁽¹⁾			175	U-MOSIV U-MOSVIII-H U-MOSIX-H	
		6 to 2	TK50S04K3L ⁽¹⁾ TK65S04N1L ^{(1)*}	TK100S04N1L*	TK100F04K3 TK100F04K3L ⁽¹⁾				TK50A04K3 TK80A04K3L ⁽¹⁾
		1.5 to 0.7	TK1R4S04PB*		TK1R4F04PB* TK200F04N1L*	TKR74F04PB*			TK1R5R04PB**
	60	55 to 28	TK8S06K3L ⁽¹⁾	TK20S06K3L ⁽¹⁾					
		19 to 10	TK25S06N1L ^{(1)*} TK30S06K3L ⁽¹⁾	TK40S06N1L ^{(1)*} TK45S06K3L ⁽¹⁾					
		6 to 3	TK80S06K3L ⁽¹⁾	TK90S06N1L*	TK100F06K3	TK130F06K3			
	75	4.3			TK80F08K3				
		48 to 28	TK7S10N1Z ^{(1)*} TK33S10N1L ^{(1)**} TK33S10N1Z ^{(1)*}	TK11S10N1L ^{(1)*} TK55S10N1*					
		10 to 6							
	P-ch	-40	2.4			TK160F10N1*			TK160F10N1L**
44 to 22			TJ10S04M3L ⁽¹⁾ TJ40S04M3L ⁽¹⁾ TJ60S04M3L ⁽¹⁾	TJ20S04M3L ⁽¹⁾ TJ80S04M3L ⁽¹⁾					
-60		10 to 1			TJ100F04M3L ⁽¹⁾ TJ200F04M3L				
		104 to 50	TJ8S06M3L ⁽¹⁾	TJ15S06M3L ⁽¹⁾					
		22 to 5	TJ30S06M3L ⁽¹⁾ TJ50S06M3L ⁽¹⁾	TJ60S06M3L ⁽¹⁾	TJ100F06M3L ⁽¹⁾ TJ150F06M3L ⁽¹⁾				
-100	130	TJ15S10M3							

Note (1): With protection Zener diode between gate and source.
ゲート-ソース間保護ツェナーダイオードあり。

*: New Product **: Under Development
*: 新製品 **: 開発中

Small Package Series for Automotive Applications 車載対応小型パッケージシリーズ

The MOSFETs listed below are housed in small packages for commercial applications and support channel temperatures (Tch) up to 175°C. (except some devices)
小型民生パッケージを活用したTch = 175°Cに対応したシリーズです。(一部製品を除く)

	V _{DSS} (V)	Tch (°C)	R _{DS(ON)} Max (mΩ)	150°C					175°C		
				SSM	UDFN6B	UFM	UF6	SOT-23F	PS-8	TSON Advance	SOP Advance
N-ch	20	3000	SSM3K35FS								
		850 to 123	SSM3K36FS SSM3K56FS		SSM3K36TU SSM3K122TU						
		55 to 28			SSM3K121TU SSM3K123TU	SSM6K404TU SSM6K403TU					
	30	4000	SSM3K44FS								
		240 to 100			SSM3K127TU SSM3K116TU		SSM3K336R SSM3K329R				
		56 to 19		SSM6K504NU	SSM3K131TU	SSM6K406TU	SSM3K335R SSM3K333R				
	40	9 to 4		SSM6K513NU*							
		32 to 11		SSM6K514NU*				TPCP8011 TPCP8010 TPCP8009			
		9 to 3						TPCC8069	TPCA8085 TPH4R304NC** TPCA8083		
	60	1750	SSM3K72FS*								
440 to 145				SSM3K2615TU	SSM6K407TU	SSM3K2615R* SSM3K318R*					
52 to 51			SSM6K341NU**			SSM3K341R* *	TPCP8013				
21 to 5							TPCP8012	TPCC8070	TPCA8086 TPCA8084		
100	92 to 69		SSM6K361NU**			SSM3K361R* *					
P-ch	-20	8000	SSM3J35FS								
		1310	SSM3J36FS		SSM3J36TU						
		64				SSM6J50TU					
	-30	12000	SSM3J15FS								
		790 to 145			SSM3J112TU SSM3J118TU SSM3J117TU	SSM6J410TU SSM6J402TU SSM6J401TU					
		3									
	-40	53 to 5						TPCP8109 TPCP8107	TPCC8106	TPCA8121 TPCA8124 TPCA8122	
		360 to 117					SSM3J356R* SSM3J351R**	TPCP8111			
-60	40 to 11						TPCP8110	TPCC8107	TPCA8123 TPCA8125		
	N-ch x 2	40	36.3				TPCP8207				
N-ch + P-ch	40/-40	36.3/56.8					TPCP8407				

*: Guaranteed at up to 175°C
★: 175°C対応品です。

*: New Product **: Under Development
*: 新製品 **: 開発中

If you want to use any devices listed above for "Unintended Use" including automotive applications, contact your local Toshiba sales representative.
車載含む特定用途でご利用の場合は、当社営業窓口へご連絡ください。

For detailed information about individual MOSFETs, visit our website or see the SEMICONDUCTOR GENERAL CATALOG.
個別の製品の詳細につきましては、ウェブサイトまたは東芝半導体製品総覧表にてご確認ください。

■ Electronic Power Steering (EPS) System 電動パワーステアリング

EPS systems are finding widespread use in automobiles to improve mileage. Here are block diagrams of EPS systems that use power MOSFETs for motor driver, power supply and motor relay applications in EPS systems.

燃費向上のため搭載が進む電動パワーステアリング (EPS) の、モータドライバ、電源・モータリレー用のパワーMOSFETを中心としたシステム構成図です。

System Block Diagram システム構成図

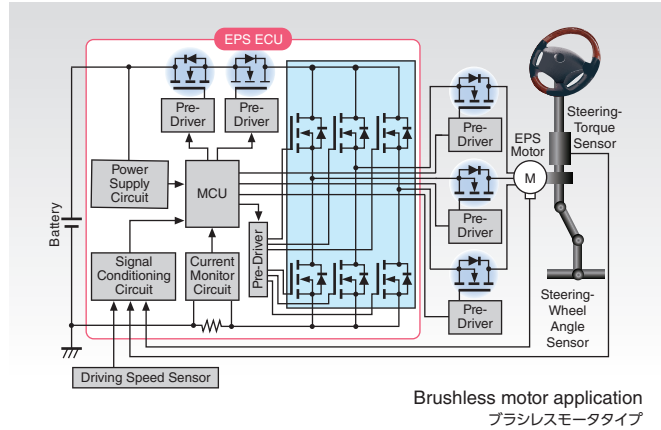

Brushless motor application
ブラシレスモータタイプ

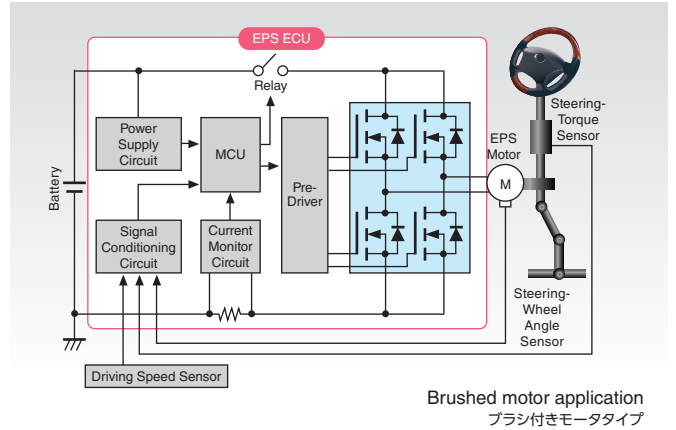

Brushed motor application
ブラシ付きモータタイプ

Block ブロック	Package パッケージ	Part Number 品番	Polarity 極性	V _{bss} (V)	I _D (A)	R _{DS(ON)} max (mΩ)	T _{ch} (°C)	Rel.Level 信頼性レベル
Motor Control Semicon. Relays モータ制御 半導体リレー	DPAK+	TK65S04N1L	Nch	40	65	4.3	175	(A)
		TK100S04N1L	Nch	40	100	2.3	175	(A)
	TO-220SM(W)	TK100F04K3L	Nch	40	100	3.0	175	(A)
		TK200F04N1L	Nch	40	200	0.9	175	(A)

(A) AEC-Q101 Qualified

(A) AEC-Q101 適合

■ Pump Motors ポンプモータ

Electric motor pumps are becoming increasingly used in various automotive applications in order to improve mileage. The DPAK+ Series features ultra-low ON-resistance due to the use of a nanoscale silicon process and a low-resistance Cu connector structure.

燃費向上のため各種ポンプの電動モータ化が進んでいます。DPAK+シリーズは、シリコンチップの超微細加工技術とCuコネクタによる低接続抵抗の融合によって超低オン抵抗を実現した新製品です。

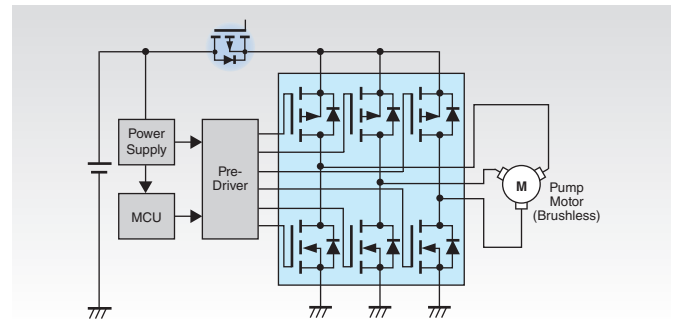

Brushless motor application
ブラシレスモータタイプ

Block ブロック	Package パッケージ	Part Number 品番	Polarity 極性	V _{bss} (V)	I _D (A)	R _{DS(ON)} max (mΩ)	T _{ch} (°C)	Rel.Level 信頼性レベル
Motor Control Reverse battery protection モータ制御 バッテリー逆接保護	DPAK+	TK35S04K3L	Nch	40	35	10.3	175	(A)
		TK65S04N1L	Nch	40	65	4.3	175	(A)
		TK100S04N1L	Nch	40	100	2.3	175	(A)
		TJ40S04M3L	Pch	-40	-40	9.1	175	(A)
		TJ60S04M3L	Pch	-40	-60	6.3	175	(A)
		TJ80S04M3L	Pch	-40	-80	5.2	175	(A)
	SOP Advance	TPCA8085	Nch	40	40	5.7	175	(B)
		TPCA8083	Nch	40	60	3.3	175	-
		TPCA8124	Pch	-40	-35	10.5	175	(B)
	TSON Advance	TPCA8122	Pch	-40	-60	5.0	175	(B)
		TPCC8069	Nch	40	30	8.1	175	(B)
		TPCC8106	Pch	-40	-30	12.3	175	(B)

(A) AEC-Q101 Qualified

(B) AEC-Q101 Under consideration

(A) AEC-Q101 適合

(B) AEC-Q101 検討中

■ Heating, Ventilation and Air-Conditioning (HVAC)

自動車用空調システム

HVAC systems are migrating to brushless motors to improve mileage. The power MOSFETs for HVAC applications feature ultra-low ON-resistance due to the use of a nanoscale silicon process and a low-resistance Cu connector structure, reducing the power consumption of the electronic control unit (ECU). Additionally, the Cu connector structure provides a higher power cycling capability than aluminum (Al) wire bonding.

燃費向上のため、自動車用空調システム (HVAC) のブラシレスモータ化が進んでいます。シリコンチップの超微細加工技術と、Cuコネクタによる低接続抵抗の融合によって、超低オン抵抗を実現し、ECUの低消費に貢献します。また、Cuコネクタ構造は、アルミボンディングタイプに対し、高パワーサイクル耐量を実現しています。

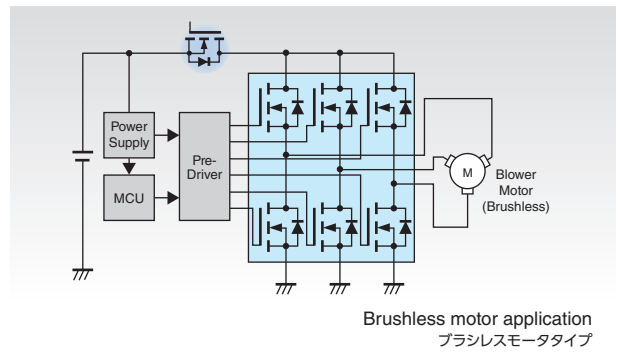

Block ブロック	Package パッケージ	Part Number 品番	Polarity 極性	V _{DSS} (V)	I _D (A)	R _{Ds(ON)} max (mΩ)	T _{ch} (°C)	Rel.Level 信頼性レベル
Motor Control Reverse battery protection モータ制御 バッテリー逆接続保護	DPAK+	TK65S04N1L	Nch	40	65	4.3	175	(A)
		TK100S04N1L	Nch	40	100	2.3	175	(A)
		TK80S06K3L	Nch	60	80	5.5	175	(A)
	TO-220SM(W)	TK90S06N1L	Nch	60	90	3.3	175	(A)
		TK100F04K3L	Nch	40	100	3.0	175	(A)
		TK100F06K3	Nch	60	100	5.0	175	(A)
		TK160F10N1	Nch	100	160	2.4	175	(B)

(A) AEC-Q101 Qualified

(B) AEC-Q101 Under consideration

(A) AEC-Q101 適合

(B) AEC-Q101 検討中

■ Electric parking brake (EPB), power sliding doors, precrash seat belt tensioners

駐車ブレーキ／パワースライドドア／プリクラッシュシートベルト

Nowadays, more and more automotive applications rely on electronic control, including electric parking brakes (EPB), power sliding doors and precrash seat belt tensioners. The H-bridge circuit configuration is most commonly used to drive motors for these applications. Fabricated using the latest silicon process, the DPAK+ MOSFET Series for motor drive applications delivers low on-resistance, as well as low wiring resistance by the use of a Cu connector. These characteristics combine to help reduce the system power consumption.

駐車ブレーキ (EPB)、パワースライドドア、プリクラッシュシートベルトなどのアプリケーションも電子制御が進んでいます。モータ駆動は、Hブリッジ構成が主流となっています。モータ駆動用MOSFETのDPAK+シリーズは、最新世代シリコンチップによるさらなる低オン抵抗と、Cuコネクタ構造による低接続抵抗を実現しており、低消費電力に貢献します。

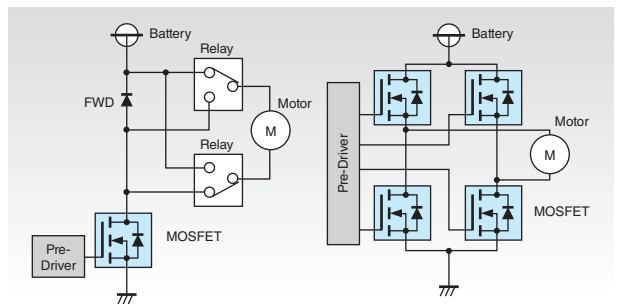

Block ブロック	Package パッケージ	Part Number 品番	Polarity 極性	V _{DSS} (V)	I _D (A)	R _{Ds(ON)} max (mΩ)	T _{ch} (°C)	Rel.Level 信頼性レベル
Motor Control モータ制御	DPAK+	TK65S04N1L	Nch	40	65	4.3	175	(A)
		TK100S04N1L	Nch	40	100	2.3	175	(A)
		TK90S06N1L	Nch	60	90	3.3	175	(A)
	TO-220SM(W)	TK100F04K3L	Nch	40	100	3.0	175	(A)
		TK200F04N1L	Nch	40	200	0.9	175	(A)
		TK100F06K3	Nch	60	100	5.0	175	(A)
		TK130F06K3	Nch	60	130	3.4	175	(A)

(A) AEC-Q101 Qualified

(A) AEC-Q101 適合

■ Junction Box ジャンクションボックス

Automotive junction boxes come in two types: those using mechanical relays and those using MOSFETs as semiconductor relays. To meet the needs of mechanical-relay drive applications, Toshiba has developed the SSM3K337R, a MOSFET in a small package (with 85% of the mounting area of the predecessor) that has active clamping circuitry for inductive loads. Toshiba also offers power MOSFETs in DPAK+ and TO-220SM(W) packages suitable for semiconductor relay applications.

ジャンクションボックスには、メカリレーを使用するものと、メカリレーに代わる半導体リレーとしてMOSFETを使用するものがあります。メカリレーを駆動するMOSFETとしては、誘導負荷に強いアクティブクランプ構造で小型パッケージ (従来より実装面積比85%) を採用したSSM3K337Rを開発しました。一方、半導体リレーとしては、DPAK+パッケージ、TO-220SM(W)パッケージなどのパワーMOSFET製品があります。

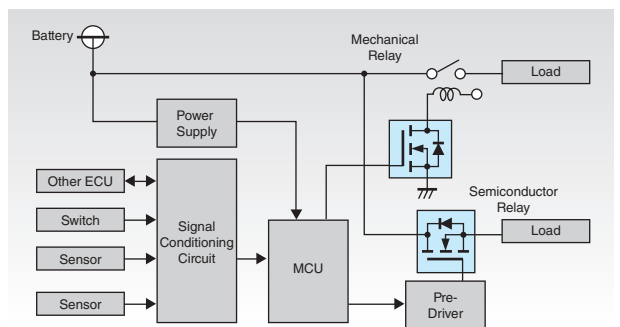

Block ブロック	Package パッケージ	Part Number 品番	Polarity 極性	V _{DSS} (V)	I _D (A)	R _{Ds(ON)} max (mΩ)	T _{ch} (°C)	Rel.Level 信頼性レベル
Mechanical Relay メカリレー	SOT-23F	SSM3K337R	Nch	38	2	200	150	(A)
		SSM3K2615R	Nch	60	2	580	150	(A)
	UFM	SSM3H137TU	Nch	34	2	295	150	(A)
Semicon. Relay 半導体リレー	DPAK+	TK100S04N1L	Nch	40	100	2.3	175	(A)
	TO-220SM(W)	TK200F04N1L	Nch	40	200	0.9	175	(A)
Power Supply 電源	DPAK+	TK25S06N1L	Nch	60	25	18.5	175	(A)

(A) AEC-Q101 Qualified

(A) AEC-Q101 適合

List of Packages

パッケージ一覧

Surface-Mount Package 表面実装パッケージ

■ 3-pin Packages 3ピンパッケージ

<p>CST3C</p> <p>Bottom View 底面図</p>	<p>CST3 (SOT-883)</p> <p>Bottom View 底面図</p>	<p>CST3B</p> <p>Bottom View 底面図</p>	<p>VESM (SOT-723)(SC-105AA)</p>	<p>SSM (SOT-416)(SC-75)</p>
<p>UFM</p>	<p>USM (SOT-323)(SC-70)</p>	<p>SOT23</p>	<p>SOT-23F</p>	<p>S-Mini (SOT-346)(SC-59)</p>
<p>New PW-Mold</p>	<p>DDPAK+</p>	<p>DDPAK (※)</p>	<p>TO-220SM(W)</p>	<p>D2DDPAK+</p>
<p>D2DDPAK</p>	<p>※ The external dimensions of DPAK packages may differ, depending on manufacturing locations. For detailed dimensions, see technical datasheets for individual products. ※ DPAKパッケージについては、生産拠点により外形寸法が異なる場合があります。詳細寸法については、各製品のデータシートをご確認ください。</p>			

■ 5-pin Packages 5ピンパッケージ

<p>ESV (SOT-553)(SC-107BB)</p>	<p>UFV</p>	<p>USV (SOT-353)(SC-88A)</p>	<p>DFN8x8</p> <p>Bottom View 底面図</p>
---	-------------------	---	---

■ 6-pin Packages 6ピンパッケージ

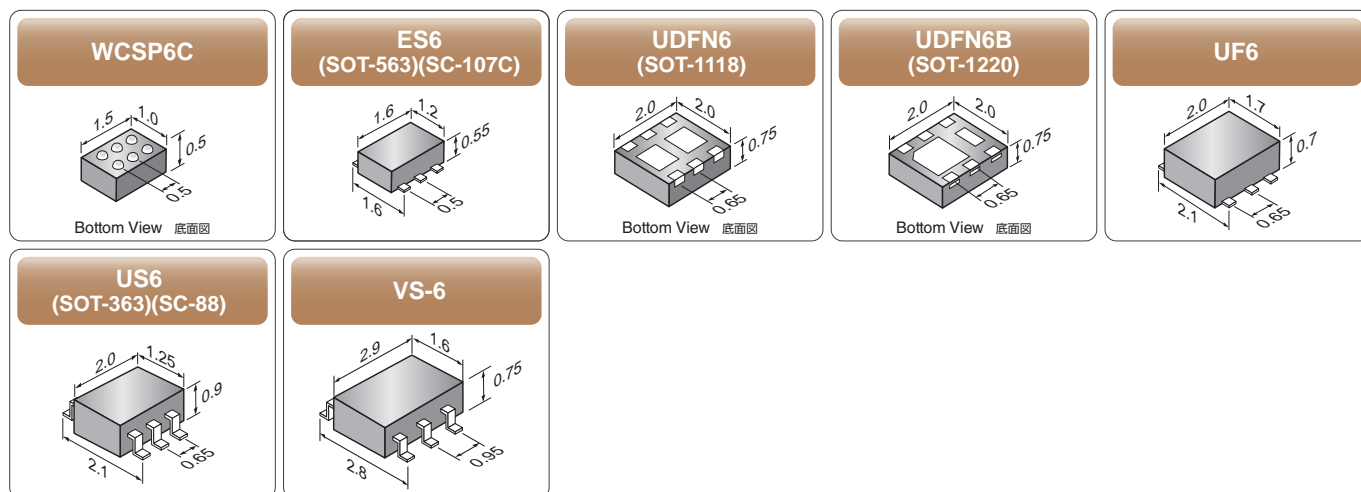

■ 8-pin Packages 8ピンパッケージ

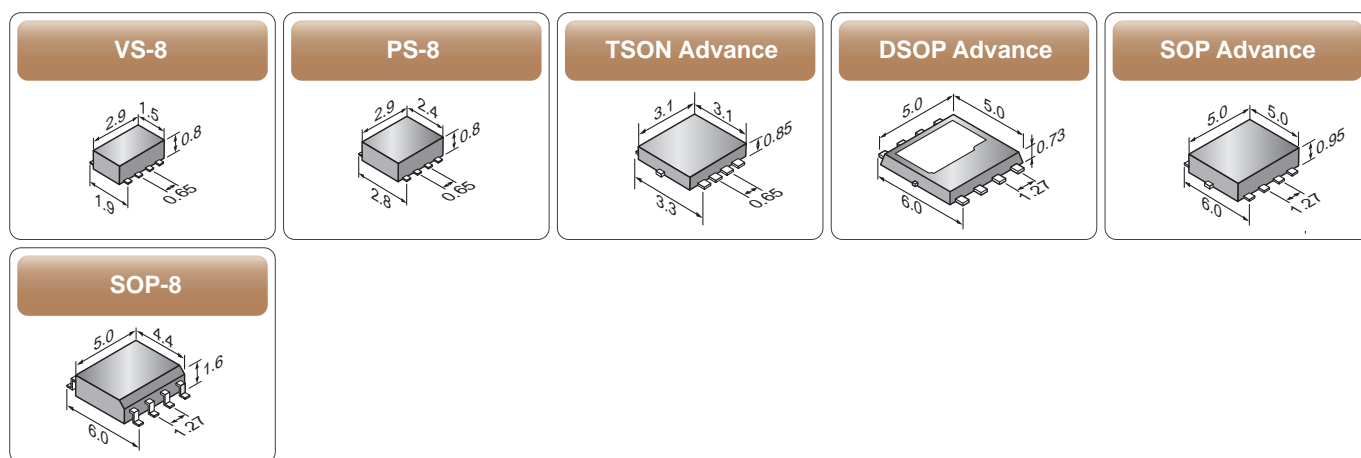

Through-Hole Package リード挿入パッケージ

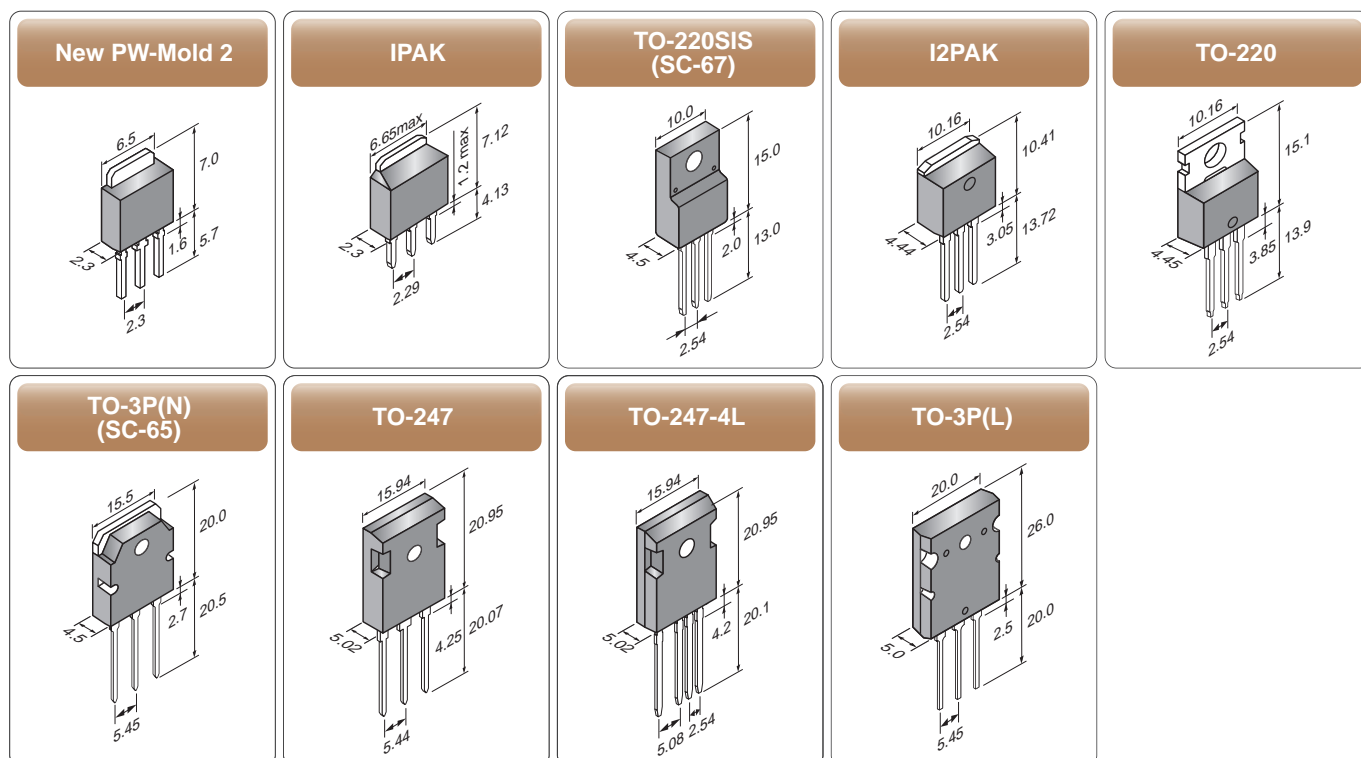

For packaging details, visit our website or see individual technical datasheets.

パッケージの詳細につきましては、ウェブサイトまたは個別データシートにてご確認ください。

Part Naming Conventions

品番付与法

Small-Signal MOSFET Series 小信号MOSFETシリーズ

SSM 3 K 116 TU

Initials of "Small-Signal MOSFET"
東芝小信号MOSFETを表します

Pin Count 端子数

Serial number of the products 製品の追番号

Polarity and internal configuration 極性および内部接続
 E: N-channel and P-channel (pre-wired as a load switch)
 Nチャネル + Pチャネル [2素子入り] (ロードスイッチ配線済み)
 G: P-channel and SBD Pチャネル + SBD [2素子入り]
 H: N-channel and SBD Nチャネル + SBD [2素子入り]
 J: P-channel, single Pチャネル [1素子入り]
 K: N-channel, single Nチャネル [1素子入り]
 L: N-channel and P-channel, dual Nチャネル + Pチャネル [2素子入り]
 N: N-channel, dual Nチャネル [2素子入り]
 P: P-channel, dual Pチャネル [2素子入り]
 Q: P-channel and PNP transistor Pチャネル + PNPトランジスタ [2素子入り]

Package パッケージ記号

3-pin	5-pin
CT..... CST3	F..... SMV
CTB... CST3B	FE..... ESV
F..... S-Mini	FU..... USV
FS..... SSM	TU..... UFV
FU..... USM	
FV..... VESM	6-pin
R..... SOT-23F	CTD ... CST6D
T..... TSM	FE..... ES6
TU..... UFM	FU..... US6
	NU..... UDFN6 / UDFN6B
4-pin	R..... TSOP6F
CT..... CST4	TU..... UF6

Multi-Pin Package Series 多ピンパッケージシリーズ

Conventional type 従来タイプ

TPC8 0 45 -H

Serial number of the products 製品の追番号

Polarity/Configuration 極性/内部接続
 0: N-channel, single Nチャネル [1素子入り] 4: N-channel and P-channel, dual Nチャネル + Pチャネル [2素子入り]
 1: P-channel, single Pチャネル [1素子入り] A: N-channel and SBD Nチャネル + SBD [2素子入り]
 2: N-channel, dual Nチャネル [2素子入り] B: P-channel and SBD Pチャネル + SBD [2素子入り]
 3: P-channel, dual Pチャネル [2素子入り] J: P-channel and NPN transistor Pチャネル + NPNトランジスタ [2素子入り]

Package パッケージ記号

TPC6 VS-6	TPC8 SOP-8
TPCF8 VS-8	TPCA8 SOP Advance
TPCP8 PS-8	TPCL4 Chip LGA
TPCC8 TSON Advance	

Additional information 付加情報
 -H: High-speed type 高速タイプ
 None: Low on-resistance type 低オン抵抗タイプ

New type 新規タイプ

TPH 4R6 0 6 N H

Series 製品シリーズ
 G: U-MOSVII
 M: U-MOSVI
 N: U-MOSVIII
 P: U-MOSIX

Polarity/Configuration 極性/内部接続
 0: N-channel, single Nチャネル [1素子入り]
 1: P-channel, single Pチャネル [1素子入り]
 2: N-channel, dual Nチャネル [2素子入り]
 3: P-channel, dual Pチャネル [2素子入り]
 4: N-channel and P-channel, dual Nチャネル + Pチャネル [2素子入り]
 A: N-channel and SBD Nチャネル + SBD [2素子入り]
 B: P-channel and SBD Pチャネル + SBD [2素子入り]

Maximum rated voltage (V_{DSS}) 最大定格電圧
 2: V_{DSS} = 15 V to 24 V
 3: V_{DSS} = 25 V to 34 V
 4: V_{DSS} = 35 V to 44 V
 5: V_{DSS} = 45 V to 54 V
 6: V_{DSS} = 55 V to 64 V
 7: V_{DSS} = 65 V to 74 V
 8: V_{DSS} = 75 V to 84 V
 9: V_{DSS} = 85 V to 94 V
 A: V_{DSS} = 95 V to 124 V
 B: V_{DSS} = 125 V to 149 V
 C: V_{DSS} = 150 V to 179 V
 D: V_{DSS} = 180 V to 199 V
 E: V_{DSS} = 200 V to 249 V
 F: V_{DSS} = 250 V to 299 V

Maximum on-resistance (at max drive conditions) (R_{DS(ON)}) オン抵抗 (最大保証駆動時の最大規格)
 R46: R_{DS(ON)} = 0.46 mΩ
 4R6: R_{DS(ON)} = 4.6 mΩ
 100: R_{DS(ON)} = 10mΩ (= 10 x 10⁰)
 101: R_{DS(ON)} = 100mΩ (= 10 x 10¹)

Additional information 付加情報
 1 to 5: Serial number of the products 製品の追番号
 A: V_{GS} = 10 V V_{GS} = 10 V駆動
 B: V_{GS} = 6.0 V V_{GS} = 6.0 V駆動
 C: V_{GS} = 4.5 V V_{GS} = 4.5 V駆動
 D: V_{GS} = 2.5 V V_{GS} = 2.5V駆動
 E: V_{GS} = 2.0 V V_{GS} = 2.0 V駆動
 F: V_{GS} = 1.8 V V_{GS} = 1.8 V駆動
 H: Low r_g type, V_{GS} = 10 V 低ゲート抵抗 (r_g) タイプ, V_{GS} = 10 V駆動
 M: Low r_g type, V_{GS} = 6.0 V 低ゲート抵抗 (r_g) タイプ, V_{GS} = 6.0 V駆動
 L: Low r_g type, V_{GS} = 4.5 V 低ゲート抵抗 (r_g) タイプ, V_{GS} = 4.5 V駆動
 Q: Tch(max) = Guaranteed up to 175°C+ZD Tch(max) = 175°C保証 + ZD
 R: Tch(max) = Guaranteed up to 150°C+ZD Tch(max) = 150°C保証 + ZD
 S: Tch(max) = Guaranteed up to 175°C Tch(max) = 175°C保証
 T: Tch(max) = Guaranteed up to 150°C Tch(max) = 150°C保証

Package パッケージ記号

TP6 VS-6	TPN TSON Advance
TP8 SOP-8	TPP PS-8
TPF VS-8	TPW DSOP Advance
TPH SOP Advance	TPZ DSON Advance

3-pin MOSFET Series 3端子MOSFETシリーズ

Conventional type 従来タイプ

2SK****

N-Channel MOSFET NチャネルMOSFET

2SJ****

P-Channel MOSFET PチャネルMOSFET

Conventional type 従来タイプ

TK 11 S 10 N 1 L

Additional information 付加情報

- 1: Low-capacitance type 高速スイッチングタイプ
- 3: Low-on-resistance type 低オン抵抗タイプ
- 5: Fast body diode type 高速ボディダイオード内蔵タイプ

10% of maximum rated voltage (V_{DSS}) 最大定格電圧 V_{DSS} × 10%表示

- 06: V_{DSS} = 60 V (= 6 x 10)
60: V_{DSS} = 600 V (= 60 x 10)

Package パッケージ記号

- | | |
|----------------|------------------------|
| A: TO-220SIS | N: TO-247 |
| C: I2PAK | P: DPAK / New PW-Mold |
| E: TO-220 | Q: IPAK / New PW-Mold2 |
| F: TO-220SM(W) | R: D2PAK+ |
| G: D2PAK | S: DPAK+ |
| J: TO-3P(N) | V: DFN8 x 8 |
| L: TO-3P(L) | X: TFP |
| M: TO-3P(N)IS | Z: TO-247-4L |

Current rating (I_D) 電流定格

- 8: I_D = 8 A
65: I_D = 65 A

Polarity 極性

- TK: N-channel Nチャネル
TJ: P-channel Pチャネル

Additional information 付加情報

- L: V_{GS} = 4.5 V or V_{GS} = 6.0 V V_{GS} = 4.5 V駆動 または V_{GS} = 6.0 V駆動
Z: Zener Diode built between Gate-Source
Where Z and L are both allocated, only L will be indicated.
ゲートソース間にツェナーダイオードあり。LとZが両立する場合はLと表示。

Series 製品シリーズ

- | | |
|--------------|--------------|
| A: π-MOSIV | M: U-MOSVI |
| C: π-MOSVI | N: U-MOSVII |
| D: π-MOSVII | U: DTMOSII |
| E: π-MOSVIII | V: DTMOSIII |
| J: U-MOSIII | W: DTMOSIV |
| K: U-MOSIV | X: DTMOSIV-H |

New type 新規タイプ

TK R74 F 04 P B

Additional information 付加情報

- A: V_{GS} = 10 V V_{GS} = 10 V駆動 5: Fast body diode type 高速ボディダイオード内蔵タイプ
B: V_{GS} = 6.0 V V_{GS} = 6.0 V駆動
C: V_{GS} = 4.5 V V_{GS} = 4.5 V駆動

Series 製品シリーズ

- P: U-MOSIX

10% of maximum rated voltage (V_{DSS}) 最大定格電圧 V_{DSS} × 10%表示

- 04: V_{DSS} = 40 V (= 4 x 10)
60: V_{DSS} = 600 V (= 60 x 10)

Package パッケージ記号

- | | |
|----------------|------------------------|
| A: TO-220SIS | N: TO-247 |
| C: I2PAK | P: DPAK / New PW-Mold |
| E: TO-220 | Q: IPAK / New PW-Mold2 |
| F: TO-220SM(W) | R: D2PAK+ |
| G: D2PAK | S: DPAK+ |
| J: TO-3P(N) | V: DFN8 x 8 |
| L: TO-3P(L) | X: TFP |
| M: TO-3P(N)IS | Z: TO-247-4L |

Maximum on-resistance (at max drive conditions) (R_{DS(ON)}) オン抵抗(最大保証駆動値の最大定格)

|V_{DSS}| < 400 V Products |V_{DSS}| < 400 V製品 |V_{DSS}| ≥ 400 V Products |V_{DSS}| ≥ 400 V製品

- | | |
|---|--|
| R74: R _{DS(ON)} = 0.74 mΩ | R38: R _{DS(ON)} = 0.38 mΩ |
| 7R4: R _{DS(ON)} = 7.4 mΩ | 3R8: R _{DS(ON)} = 3.8 mΩ |
| 740: R _{DS(ON)} = 74 mΩ (= 74 x 10 ⁰) | 038: R _{DS(ON)} = 38 mΩ |
| 741: R _{DS(ON)} = 740 mΩ (= 74 x 10 ¹) | 380: R _{DS(ON)} = 380 mΩ |
| | 3K8: R _{DS(ON)} = 3.8 Ω (3800 mΩ) |

Polarity 極性

- TK: N-channel Nチャネル
TJ: P-channel Pチャネル

Web Simulator

Web シミュレータのご紹介

Toshiba offers the Web Simulator that allows you to perform various analyses online. After user registration, you will be granted free access to it.

インターネット上で様々な解析が可能なWebシミュレータを用意しました。ユーザー登録をしていただくことでご自由にお使いいただけます。



- The Web Simulator allows you to simulate the MOSFET performance under various voltage and temperature conditions.
- You can analyze the switching waveforms and power efficiencies of MOSFETs in AC/DC and DC/DC converter applications.
- You can also simulate PFC, full-bridge, flyback and synchronous buck converters.
- In addition, you can simulate the behaviors of LDO regulators and load switch ICs.

- 電圧や温度などさまざまな条件下で、MOSFETの特性を確認することができます。
- AC-DCコンバータ、DC-DCコンバータでのスイッチング波形と電源効率の解析が可能です。
- PFC、フルブリッジ、フライバック、同期整流型バックコンバータのシミュレーションが可能です。
- LDOレギュレータとロードスイッチICの動作解析が可能です。

■ Functions for MOSFET Analysis MOSFETで使用可能な機能

● INTERACTIVE DATASHEET <Device characteristics simulation> <デバイス特性シミュレーション>

You can view performance curves in a datasheet under various conditions. データシートの特性カーブを条件を変えて簡単に確認可能です。

You can change test conditions for various electrical characteristics. 各項目について測定条件を変更可能

Nine test items are available for simulation. 9つのテスト項目でシミュレート可能

You can view waveforms under the specified conditions. 設定した条件で波形を表示可能

● APPLICATION DESIGNER <Circuit simulation> <回路シミュレーション>

You can simulate various power supply topologies for AC-DC and DC-DC converters. 各種電源トポロジー(AC-DCコンバータとDC-DCコンバータ)の回路シミュレーションが可能です。

Generates circuit diagrams automatically using the selected power supply topology and MOSFET. 選択された電源トポロジー、MOSFETで回路を自動生成

Shows waveforms for major components. 主要部品の動作波形を表示

You can also view the power efficiency curves, and power losses in a MOSFET. 電源効率カーブ、MOSFETの各部位における損失も表示可能

SALES OFFICES

SUBSIDIARIES AND AFFILIATES

(As of April 15, 2015)

Toshiba America

Electronic Components, Inc.

- Irvine, Headquarters
Tel: (949)462-7700 Fax: (949)462-2200
- Buffalo Grove (Chicago)
Tel: (847)484-2400 Fax: (847)541-7287
- Duluth/Atlanta
Tel: (770)931-3363 Fax: (770)931-7602
- El Paso
Tel: (915)533-4242
- Marlborough
Tel: (508)481-0034 Fax: (508)481-8828
- Parsippany
Tel: (973)541-4715 Fax: (973)541-4716
- San Jose
Tel: (408)526-2400 Fax: (408)526-2410
- Wixom (Detroit)
Tel: (248)347-2607 Fax: (248)347-2602

TOSHIBA América do Sul Ltda.

Tel: (011)4083-7978

Toshiba India Private Ltd.

- New Delhi Office
Tel: (0124)499-6600 Fax: (0124)499-6611
- Bangalore Office
Tel: (080)251-90800 Fax: (080)490-91945

Toshiba Electronics Europe GmbH

- Düsseldorf Head Office
Tel: (0211)5296-0 Fax: (0211)5296-400
- France Branch
Tel: (1)47282181
- Italy Branch
Tel: (039)68701 Fax: (039)6870205
- Munich Office
Tel: (089)20302030 Fax: (089)203020310
- Spain Branch
Tel: (91)660-6798 Fax: (91)660-6799
- Sweden Branch
Tel: (08)704-0900 Fax: (08)80-8459
- U.K. Branch
Tel: (1932)841600

Toshiba Vietnam Consumer Products Co.,Ltd.

Tel: (043)776-5950 Fax: (043)776-5956

Toshiba Electronics Asia (Singapore) Pte. Ltd.

Tel: (6278)5252 Fax: (6271)5155

Toshiba Electronics Service (Thailand) Co., Ltd.

Tel: (02)835-3491 Fax: (02)835-3490

Toshiba Electronics Trading (Malaysia) Sdn. Bhd.

- Kuala Lumpur Head Office
Tel: (03)5631-6311 Fax: (03)5631-6307
- Penang Office
Tel: (04)226-8523 Fax: (04)226-8515

Toshiba Electronics (China) Co., Ltd.

- Shanghai Head Office
Tel: (021)6139-3888 Fax: (021)6190-8288
 - Beijing Branch
Tel: (010)6590-8796 Fax: (010)6590-8791
 - Chengdu Branch
Tel: (028)8675-1773 Fax: (028)8675-1065
 - Hangzhou Office
Tel: (0571)8717-5004 Fax: (0571)8717-5013
 - Nanjing Office
Tel: (025)8689-0070 Fax: (025)8689-0125
 - Qingdao Branch
Tel: (532)8579-3328 Fax: (532)8579-3329
 - Shenzhen Branch
Tel: (0755)3686-0880 Fax: (0755)3686-0816
 - Dalian Branch
Tel: (0411)8368-6882 Fax: (0411)8369-0822
 - Xiamen Branch
Tel: (0592)226-1398 Fax: (0592)226-1399
 - Dongguan Branch
Tel: (0769)8155-6858 Fax: (0769)8155-6368
- #### Toshiba Electronics Asia, Ltd.
- Tel: 2375-6111 Fax: 2375-0969
- #### Toshiba Electronics Korea Corporation
- Tel: (02)3484-4334 Fax: (02)3484-4302
- #### Toshiba Electronic Components Taiwan Corporation
- Tel: (02)2508-9988 Fax: (02)2508-9999



公式 YouTube のご案内

東芝 セミコンダクター&ストレージ社の製品や技術、イベントをご紹介する動画を YouTube で公開しています。

(←登録にはこちらのQRコードをご利用ください。)

* YouTube は、Google,Inc.の商標または登録商標です。



公式ツイッター (Twitter) のご案内

東芝 セミコンダクター&ストレージ社のニュースリリース/新製品情報や開催中の展示博覧会の様子などをリアルタイムに配信しています。

ツイッターをご利用中の方はぜひフォローをお願いします。

(←登録にはこちらのQRコードをご利用ください。)

* Twitter は、Twitter,Inc.の商標または登録商標です。



メールマガジンのご案内

東芝 セミコンダクター&ストレージ社のメールマガジンを配信しています。

月1~2回、当社製品の最新情報をピックアップしてお届けします。

その他にも、無料セミナー開催のお知らせなど、耳よりな情報も満載しています。

(←登録にはこちらのQRコードをご利用ください。)

RESTRICTIONS ON PRODUCT USE

- ▶ Toshiba Corporation, and its subsidiaries and affiliates (collectively "TOSHIBA"), reserve the right to make changes to the information in this document, and related hardware, software and systems (collectively "Product") without notice.
- ▶ This document and any information herein may not be reproduced without prior written permission from TOSHIBA. Even with TOSHIBA's written permission, reproduction is permissible only if reproduction is without alteration/omission.
- ▶ Though TOSHIBA works continually to improve Product's quality and reliability, Product can malfunction or fail. Customers are responsible for complying with safety standards and for providing adequate designs and safeguards for their hardware, software and systems which minimize risk and avoid situations in which a malfunction or failure of Product could cause loss of human life, bodily injury or damage to property, including data loss or corruption. Before customers use the Product, create designs including the Product, or incorporate the Product into their own applications, customers must also refer to and comply with (a) the latest versions of all relevant TOSHIBA information, including without limitation, this document, the specifications, the data sheets and application notes for Product and the precautions and conditions set forth in the "TOSHIBA Semiconductor Reliability Handbook" and (b) the instructions for the application with which the Product will be used with or for. Customers are solely responsible for all aspects of their own product design or applications, including but not limited to (a) determining the appropriateness of the use of this Product in such design or applications; (b) evaluating and determining the applicability of any information contained in this document, or in charts, diagrams, programs, algorithms, sample application circuits, or any other referenced documents; and (c) validating all operating parameters for such designs and applications. **TOSHIBA ASSUMES NO LIABILITY FOR CUSTOMERS' PRODUCT DESIGN OR APPLICATIONS.**
- ▶ **PRODUCT IS NEITHER INTENDED NOR WARRANTED FOR USE IN EQUIPMENTS OR SYSTEMS THAT REQUIRE EXTRAORDINARILY HIGH LEVELS OF QUALITY AND/OR RELIABILITY, AND/OR A MALFUNCTION OR FAILURE OF WHICH MAY CAUSE LOSS OF HUMAN LIFE, BODILY INJURY, SERIOUS PROPERTY DAMAGE AND/OR SERIOUS PUBLIC IMPACT ("UNINTENDED USE").** Except for specific applications as expressly stated in this document, Unintended Use includes, without limitation, equipment used in nuclear facilities, equipment used in the aerospace industry, medical equipment, equipment used for automobiles, trains, ships and other transportation, traffic signaling equipment, equipment used to control combustions or explosions, safety devices, elevators and escalators, devices related to electric power, and equipment used in finance-related fields. **IF YOU USE PRODUCT FOR UNINTENDED USE, TOSHIBA ASSUMES NO LIABILITY FOR PRODUCT.** For details, please contact your TOSHIBA sales representative.
- ▶ Do not disassemble, analyze, reverse-engineer, alter, modify, translate or copy Product, whether in whole or in part.
- ▶ Product shall not be used for or incorporated into any products or systems whose manufacture, use, or sale is prohibited under any applicable laws or regulations.
- ▶ The information contained herein is presented only as guidance for Product use. No responsibility is assumed by TOSHIBA for any infringement of patents or any other intellectual property rights of third parties that may result from the use of Product. No license to any intellectual property right is granted by this document, whether express or implied, by estoppel or otherwise.
- ▶ **ABSENT A WRITTEN SIGNED AGREEMENT, EXCEPT AS PROVIDED IN THE RELEVANT TERMS AND CONDITIONS OF SALE FOR PRODUCT, AND TO THE MAXIMUM EXTENT ALLOWABLE BY LAW, TOSHIBA (1) ASSUMES NO LIABILITY WHATSOEVER, INCLUDING WITHOUT LIMITATION, INDIRECT, CONSEQUENTIAL, SPECIAL, OR INCIDENTAL DAMAGES OR LOSS, INCLUDING WITHOUT LIMITATION, LOSS OF PROFITS, LOSS OF OPPORTUNITIES, BUSINESS INTERRUPTION AND LOSS OF DATA, AND (2) DISCLAIMS ANY AND ALL EXPRESS OR IMPLIED WARRANTIES AND CONDITIONS RELATED TO SALE, USE OF PRODUCT, OR INFORMATION, INCLUDING WARRANTIES OR CONDITIONS OF MERCHANTABILITY, FITNESS FOR A PARTICULAR PURPOSE, ACCURACY OF INFORMATION, OR NON-INFRINGEMENT.**
- ▶ Do not use or otherwise make available Product or related software or technology for any military purposes, including without limitation, for the design, development, use, stockpiling or manufacturing of nuclear, chemical, or biological weapons or missile technology products (mass destruction weapons). Product and related software and technology may be controlled under the applicable export laws and regulations including, without limitation, the Japanese Foreign Exchange and Foreign Trade Law and the U.S. Export Administration Regulations. Export and re-export of Product or related software or technology are strictly prohibited except in compliance with all applicable export laws and regulations.
- ▶ Please contact your TOSHIBA sales representative for details as to environmental matters such as the RoHS compatibility of Product. Please use Product in compliance with all applicable laws and regulations that regulate the inclusion or use of controlled substances, including without limitation, the EU RoHS Directive. **TOSHIBA ASSUMES NO LIABILITY FOR DAMAGES OR LOSSES OCCURRING AS A RESULT OF NONCOMPLIANCE WITH APPLICABLE LAWS AND REGULATIONS.**

製品取り扱い上のお願い

- ▶ 本資料に掲載されているハードウェア、ソフトウェアおよびシステム(以下、本製品という)に関する情報等、本資料の掲載内容は、技術の進歩などにより予告なしに変更されることがあります。
- ▶ 文書による当社の事前の承諾なしに本資料の転載複製を禁じます。また、文書による当社の事前の承諾を得て本資料を転載複製する場合でも、記載内容に一切変更を加えたり、削除したりしないでください。
- ▶ 当社は品質、信頼性の向上に努めていますが、半導体・ストレージ製品は一般に誤作動または故障する場合があります。本製品をご使用頂く場合は、本製品の誤作動や故障により生命・身体・財産が侵害されることのないように、お客様の責任において、お客様のハードウェア・ソフトウェア・システムに必要な安全設計を行うことをお願いします。なお、設計および使用に際しては、本製品に関する最新の情報(本資料、仕様書、データシート、アプリケーションノート、半導体信頼性ハンドブックなど)および本製品が使用される機器の取扱説明書、操作説明書などをご確認の上、これに従ってください。また、上記資料などに記載の製品データ、図、表などに示す技術的な内容、プログラム、アルゴリズムその他応用回路例などの情報を使用する場合は、お客様の製品単独およびシステム全体で十分に評価し、お客様の責任において適用可否を判断してください。
- ▶ 本製品は、特別に高い品質・信頼性が要求され、またはその故障や誤作動が生命・身体に危害を及ぼす恐れ、膨大な財産損害を引き起こす恐れ、もしくは社会に深刻な影響を及ぼす恐れのある機器(以下"特定用途"という)に使用されることは意図されていませんし、保証もされていません。特定用途には原子力関連機器、航空・宇宙機器、医療機器、車載・輸送機器、列車・船舶機器、交通信号機器、燃焼・爆発制御機器、各種安全関連機器、昇降機器、電力機器、金融関連機器などが含まれますが、本資料に個別に記載する用途は除きます。特定用途に使用された場合には、当社は一切の責任を負いません。なお、詳細は当社営業窓口までお問い合わせください。
- ▶ 本製品を分解、解析、リバースエンジニアリング、改造、改変、翻案、複製等しないでください。
- ▶ 本製品を、国内外の法令、規則及び命令により、製造、使用、販売を禁止されている製品に使用することはできません。
- ▶ 本資料に掲載してある技術情報は、製品の代表的動作・応用を説明するためのもので、その使用に際して当社及び第三者の知的財産権その他の権利に対する保証または実施権の許諾を行うものではありません。
- ▶ 別途、書面による契約またはお客様と当社が合意した仕様書がない限り、当社は、本製品および技術情報に関して、明示的にも黙示的にも一切の保証(機能動作の保証、商品性の保証、特定目的への合致の保証、情報の正確性の保証、第三者の権利の非侵害保証を含むがこれに限らない。)をしておりません。
- ▶ 本製品、または本資料に掲載されている技術情報を、大量破壊兵器の開発等の目的、軍事利用の目的、あるいはその他軍事用途の目的で使用しないでください。また、輸出に際しては、「外国為替及び外国貿易法」、「米国輸出管理規則」等、適用ある輸出関連法令を遵守し、それらの定めるところにより必要な手続を行ってください。
- ▶ 本製品のRoHS適合性など、詳細につきましては製品個別に必ず当社営業窓口までお問い合わせください。本製品のご使用に際しては、特定の物質の含有・使用を規制するRoHS指令等、適用ある環境関連法令を十分調査の上、かかる法令に適合するようご使用ください。お客様がかかる法令を遵守しないことにより生じた損害に関して、当社は一切の責任を負いかねます。

【お問い合わせ先】

TOSHIBA

©2016 TOSHIBA CORPORATION

Previous edition: BCE0082L/BCJ0082L

TOSHIBA CORPORATION Semiconductor & Storage Products Company

株式会社 東芝 セミコンダクター&ストレージ社

http://toshiba.semicon-storage.com/