



Grayhill, Inc.

**62S11-H9-060SH**

Número da peça:

62S11-H9-060SH

Fabricante / Marca:

Grayhill, Inc.

Descrição do Produto

ROTARY ENCODER OPTICAL 32PPR

Folhas de dados:

 62S11-H9-060SH.pdf

Status de RoHS

 Sem chumbo / acordo com RoHS

Navio De

Hong Kong

Caminho de embarque

DHL/Fedex/TNT/UPS/EMS

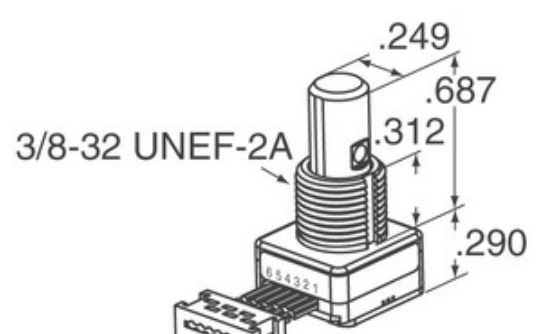

Connector:  
Amp Pt.# 215083-6 or equivalent



Imagem pode ser representação. Veja as especificações para detalhes do produto.

**Especificações do 62S11-H9-060SH**

NÚMERO DA PEÇA 62S11-H9-060SH

FABRICANTE Grayhill, Inc.

DESCRIÇÃO ROTARY ENCODER OPTICAL 32PPR

STATUS SEM CHUMBO / STATUS ROHS Sem chumbo / acordo com RoHS

FICHA DE DADOS  62S11-H9-060SH.pdf

TENSÃO - FORNECIMENTO 5V

ESTILO DE ACABAMENTO Cable Leads

SÉRIE 62S

VIDA DE ROTAÇÃO (CICLOS MIN) 1M

PULSOS POR REVOLUÇÃO 32

TIPO DE SAÍDA Quadrature (Incremental)

OUTROS NOMES 62S11H9060SH

ORIENTAÇÃO Vertical

TIPO DE MONTAGEM Panel Mount

NÍVEL DE SENSIBILIDADE À UMIDADE (MSL) 1 (Unlimited)

TEMPO DE ENTREGA PADRÃO DO FABRICANTE 8 Weeks

STATUS SEM CHUMBO / STATUS DE ROHS Lead free / RoHS Compliant

TIPO ENCODER Optical

DETENTOR Yes







CONSTRUÍDO EM MUDAR Yes

TIPO DE ATUADOR 1/4" Dia Flatted End

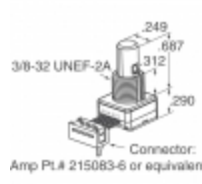
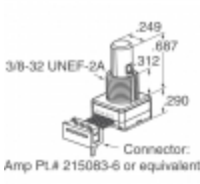
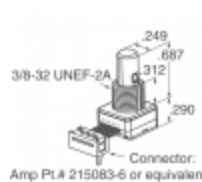
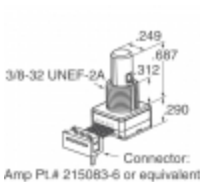
**Tags relacionadas**

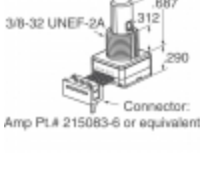
|                                      |   |                                       |
|--------------------------------------|---|---------------------------------------|
| Grayhill, Inc. 62S11-H9-060SH        | Distribuidor 62S11-H9-060SH               | Fornecedor 62S11-H9-060SH             |
| Preço 62S11-H9-060SH                 | Imagens de 62S11-H9-060SH                 | Imagem 62S11-H9-060SH                 |
| Folha de dados do 62S11-H9-060SH PDF | 62S11-H9-060SH Download da Folha de Dados | Folha de dados do 62S11-H9-060SH      |
| Estoque 62S11-H9-060SH               | Comprar 62S11-H9-060SH                    | Comprar Grayhill, Inc. 62S11-H9-060SH |
| Grayhill, Inc. 62S11-H9-060SH        | Fornecedor Grayhill, Inc.                 | Distribuidor Grayhill, Inc.           |
| Grayhill, Inc. 62S11-H9-060SH        | Grayhill Inc. 62S11-H9-060SH              |                                       |

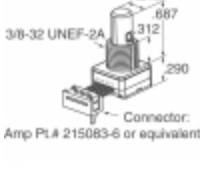
**produtos relacionados**

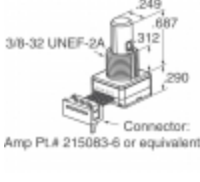
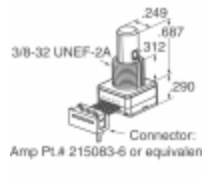
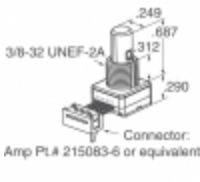
|   |  |
|---|--|
|  <p><b>62S11-L0-040C</b><br/>Fabricantes: Grayhill, Inc.<br/>Descrição: ROTARY ENCODER OPTICAL 32PPR<br/>Em estoque: Out stock</p> <p><b>RFQ</b></p>    |  <p><b>62S11-H9-050S</b><br/>Fabricantes: Grayhill, Inc.<br/>Descrição: ROTARY ENCODER OPTICAL 32PPR<br/>Em estoque: Out stock</p> <p><b>RFQ</b></p>  |
|  <p><b>62S11-L0-020C</b><br/>Fabricantes: Grayhill, Inc.<br/>Descrição: ROTARY ENCODER OPTICAL 32PPR<br/>Em estoque: Out stock</p> <p><b>RFQ</b></p>    |  <p><b>62S11-L0-020CH</b><br/>Fabricantes: Grayhill, Inc.<br/>Descrição: ROTARY ENCODER OPTICAL 32PPR<br/>Em estoque: Out stock</p> <p><b>RFQ</b></p> |
|  <p><b>62S11-L0-040S</b><br/>Fabricantes: Grayhill, Inc.<br/>Descrição: ROTARY ENCODER OPT 32PPR 4" CBL<br/>Em estoque: Out stock</p> <p><b>RFQ</b></p> |  <p><b>62S11-H9-040S</b><br/>Fabricantes: Grayhill, Inc.<br/>Descrição: ROTARY ENCODER OPTICAL 32PPR<br/>Em estoque: Out stock</p> <p><b>RFQ</b></p>  |
|  <p><b>62S11-H9-020S</b><br/>Fabricantes: Grayhill, Inc.<br/>Descrição: ROTARY ENCODER OPTICAL 32PPR<br/>Em estoque: Out stock</p> <p><b>RFQ</b></p>    |  <p><b>62S11-H9-P</b><br/>Fabricantes: Grayhill, Inc.<br/>Descrição: ROTARY ENCODER OPTICAL 32PPR<br/>Em estoque: Out stock</p> <p><b>RFQ</b></p>     |
|  <p><b>62S11-H9-PH</b><br/>Fabricantes: Grayhill, Inc.<br/>Descrição: ROTARY ENCODER OPTICAL 32PPR<br/>Em estoque: Out stock</p> <p><b>RFQ</b></p>      |  <p><b>62S11-H9-025S</b><br/>Fabricantes: Grayhill, Inc.<br/>Descrição: ROTARY ENCODER OPTICAL 32PPR<br/>Em estoque: Out stock</p> <p><b>RFQ</b></p>  |
|  <p><b>62S11-H9-060C</b><br/>Fabricantes: Grayhill, Inc.<br/>Descrição: ROTARY ENCODER OPTICAL 32PPR<br/>Em estoque: Out stock</p> <p><b>RFQ</b></p>    |  <p><b>62S11-H9-040C</b><br/>Fabricantes: Grayhill, Inc.<br/>Descrição: ROTARY ENCODER OPTICAL 32PPR<br/>Em estoque: Out stock</p> <p><b>RFQ</b></p>  |